



PETER PEPPER PRODUCTS

# 2025

**PRICE LIST & SPECIFICATIONS**

**Effective Jan 1, 2026**

All Prices are Suggested List Price

Updated 11.03.25



**15% Surcharge  
May Apply as Marked  
to Select Products**  
*Please request a quote for  
most accurate pricing.*

P  
E  
T  
E  
R  
  
P  
E  
P  
P  
E  
R  
  
P  
R  
O  
D  
U  
C  
T  
S



**Peter Pepper**

**had a vision: accessories designed to enliven the  
work environment and assist employees to be more productive.**

**In 1952 that vision became a reality. The mandate was clear: the strength  
of this vision must start by demanding the highest caliber of design, producing  
an inspired product line offering unparalleled selection. Peter Pepper Products has  
consistently delivered high quality products, identifying real solutions and meeting the  
price specifications of your most complex problems, yet never compromising the integrity  
of the design. But Peter Pepper's vision was also one of responsiveness and synergy.  
Establishing relationships based on partnership and performance, Peter Pepper initiated  
a new standard of attention to the client relationship, defining customer service as  
customer commitment. At Peter Pepper Products we will continue to strive  
to maintain the spirit of Peter Pepper's original vision. Design and  
Performance, diversity and practicality. Vision is fact.**

**Peter Pepper Products.**



# Product Locator

SECTION	SECTION
Advanced Training System, Tactics Plus® ..... 10	Receptacles, 'Trash & Ash' ..... 4
Artform Sculptured Coat Racks ..... 3	Recycling Bins ..... 4, NEX
Audio Visual Carts & Cabinets ..... 11	Recycling Centers ..... 4, NEX
Bulletin Boards ..... 10	Recycling Containers ..... 4
Calendar Clocks ..... 2	Revolving Writing Board/Easel ..... NEX
Carts, MultiMedia ..... 11	Rotating Magazine & Literature Racks ..... 1/1.1
Changeable Letter Directories ..... 10	Seating, Indoor/Outdoor ..... 1.2
Chart Holders HIPAA ..... 1/1.1	Signage: Patient Room & Corridors ..... 1.4
Charting Stations ..... 1	Steel, Stainless Trash & Recycling Receptacles ..... 4
Clock Wireless Systems ..... 2	SyncTech® Wireless Synchronized Clock System ..... 2.1
Clocks, Electronic Digital ..... 2	Tables ..... 4, 7.1, NEX
Clocks, Wall ..... 2, NEX	Tack Boards ..... 10
Coat Hooks & Bars ..... 3	Tackable Strips ..... 10
Coat Trees, Hangers & Racks ..... 3	Tactics Plus® Track System ..... 10
Combination Recyclers ..... 4	Tactics® Writing Surfaces ..... 10
Combination Wall Panels & Boards ..... 10	Time Systems, Wireless Synchronized Clocks ..... 2.1
Communication Boards ..... 10	Time-Zone Clocks ..... 2
Computer Support Carts ..... 11	Training Room Products ..... 10, 11, NEX
Cork Boards, Natural or ColorCork ..... 10	Trash Receptacles ..... 1.3, 4, NEX
Counters & Display Cases ..... 9	Trophy Cases ..... 9
Cube Tables, Fiberglass ..... 4, 7.1	Umbrella Stands ..... 3
Custom Display Cases & Store Display Products ..... 9	Visual Presentation Boards ..... 10
Desks ..... 1/1.1, NEX	Wall Desk ..... 1/1.1, NEX
Digital Clocks, Electronic (LED) ..... 2	Wall Display Cases ..... 9
Display Cases ..... 9	Wall File Holders ..... 1/1.1
Display Rail ..... 10	Wall Mounted Trash Receptacles ..... 4
Drum Tables, Fiberglass ..... 4, 7.1	Wastebaskets & Containers ..... 4
Easels ..... NEX	Wheelies ..... 11
Equipment Carts, Audio Visual ..... 11	White Boards (Wall & Rolling) ..... 10, 11, NEX
Exhibit Cases ..... 9	Wireless Synchronized Clocks ..... 2.1
Express Desk Fold Down Desk ..... 1/1.1	Work Station & Accessories ..... 1/1.1, 11, NEX
Fiberglass Products ..... 4	Worktables ..... NEX
Freestanding Magazine & Literature Racks ..... 1/1.1	Writing Surface Boards ..... 10, NEX
Glass Boards ..... 10	X-Ray Chart Holders ..... 1/1.1
Hat & Coat Hooks, Racks and Coat Trees ..... 3	
Healthcare Alert Signage ..... 1.4	
HIPAA Medical File & Chart Holders ..... 1/1.1	
Hospitality Carts ..... 11, NEX	
Icon Signage, Healthcare ..... 1.4	
Infection Prevention Centers ..... 1.3	
Lecterns ..... 11	
Literature Racks, Wall & Floor ..... 1/1.1	
Magazine Racks, Wall & Freestanding ..... 1/1.1	
Magnetic Boards, Glass & Porcelain ..... 10	
Mall Amenities ..... 1.3, 4, 9, NEX	
Medical and X-Ray Chart Holders ..... 1/1.1	
Message Communication Boards & Centers ..... 10	
Mobile Workstations ..... 11	
Modular Display System ..... 9	
MultiMedia Carts ..... 11	
Newspaper Racks ..... 1/1.1	
Projector Carts ..... 11	
PepperMint®/MiniMint® Showcase Collection ..... 9	
Planters, Fiberglass ..... 4	
Porcelain Writing Surfaces ..... 10	
Presentation Boards & Rails ..... 10	
Public/Exam Infection Prevention Center ..... 1.3	
Racks, Hat & Coat & Artform Collection ..... 3	
Racks, Magazine & Literature ..... 1/1.1	



# Price List Contents

To find your PPP Representative, go to the "Reps Locator" link on peterpepper.com and select your state.

## NEXSENTIALS®

- Desks • Worktables • Writing Surfaces • Waste + Recycling • Clocks

NEX

## 1/1.1 - MAGAZINE/NEWSPAPER/LITERATURE RACKS, FILE/CHART HOLDERS & MORE

- Magazine, Newspaper & Literature Racks - Wall, Freestanding & Mobile • File & Chart Holders
- HIPAA - Medical Chart Holders • Express® Desk - Folding Wall Desk

1/1.1

## 1.3 - healthFIRST®

- Infection Prevention Centers - Public & Exam - Wall Mounted

1.3

## 1.4 - ICON HEALTHCARE ALERT SIGNAGE

- Corridor Alert Signs • Patient Room Alert Signs

1.4

## 2 - CLOCKS

- Analog • Digital • Time-Zone • Electronic

2

## 2.1 - syncTECH®

- Wireless Synchronized Time - 2.4GHz & Wi-Fi

2.1

## 3 - ARTFORM® COLLECTION

- Sculptured Coat Racks • Hat & Coat Hooks and Bars • Coat Trees, Racks and Hangers
- Umbrella Stands

3

## 4 - FIBERGLASS & STEEL PRODUCTS

- Steel - Recycling Receptacles, Containers, Bins & Wastebaskets
- Fiberglass - Recycling Centers, Bins & Trash Receptacles - Planters - Drum Tables

4

## 7.1 - ANCORA®

- Drum Tables - Fiberglass

7.1

## 9 - SHOWCASE COLLECTION

- PepperMint® & MiniMint® - Freestanding, Wall Mounted & Counter Models

9

## 10 - VISUAL COMMUNICATION COLLECTION

- Tactics® Writing Surfaces- Porcelain & Glass • Tackable Panels • Combination Bulletin/Tack Boards
- Message Centers

10

## 11 - WHEELIES® MOBILE AV MEDIA SUPPORT PRODUCTS

- Lecterns • Work Stations • File Storage & Hospitality Carts
- Media Carts • Equipment Stands

11

© 11/2024

© 11/2024



# Terms & Conditions Peter Pepper Products, Inc.

PPP® Peter Pepper Products, Inc. All rights reserved.

THIS PRICE LIST SUPERSEDES ALL PREVIOUS ISSUES and is Effective January 1, 2026

## ACKNOWLEDGEMENT

Subject to availability, Peter Pepper Products (PPP®) hereby offers to sell the products referred to in its sales catalogs and any Acknowledgement or Invoice only upon the following terms and conditions. This offer is subject to acceptance only on the following terms and conditions.

These terms and conditions are hereby incorporated into any purchase order, sales acknowledgement documents and all subsequent actions relating to any of the products sold by PPP. Any additional or different terms and conditions proposed by any Buyer in any purchase order or confirmation are hereby rejected, shall not be a part of any contract binding upon PPP and such purchase order or acceptance shall constitute an acceptance of this offer.

Any and all subsequent actions by the parties shall be pursuant to these terms and conditions.

Every order is acknowledged by e-mail to the contact information provided with the purchase order.

Orders will be manufactured and invoiced based upon the information on the acknowledgement.

If there is any discrepancy, notify PPP immediately.

A work order number is assigned to all orders.

'ADD-ON' orders will be processed as a new order.

Estimated delivery time is stated from time order is placed into production and shown on acknowledgement. Peter Pepper Products, Inc. disclaims responsibility when the description is in conflict with the model number.

## DAMAGED MERCHANDISE/CLAIMS BY BUYER

The utmost care is used in packing and shipping. Our liability ends when the carrier issues a clean receipt to us (FOB). PPP shall incur no liability for damage, shortage or other cause alleged to have occurred or existed at or prior to delivery to the carrier unless full details thereof are entered on its receipt to the carrier. We are not responsible for loss or damage during transit.

All items are shipped at purchaser's risk.

All shipments should be carefully inspected by the consignee before acceptance and the delivering carrier should be requested to record any damage or shortage. If further damage is found after delivery, immediate inspection by the delivering carrier should be requested. Notification of concealed damages must be made to the delivering carrier within 3 days after delivery of merchandise. Keep all packaging materials until inspection has been made. Carrier liability ends after 3 days.

**CAUTION** • After obtaining a clear receipt for shipment, the delivering carrier is no longer responsible for damage or shortages. **Note: Subject to Inspection Notations are considered a clear delivery receipt by the Carrier.**

## DELAYS IN DELIVERY

PPP shall attempt to meet any shipment or delivery date specified, but in no event shall it be responsible or liable for failure to ship or deliver on or by any particular date.

**PPP shall not be liable to any buyer or any third party for indirect or consequential damages due to delays in the shipment or delivery of goods.**

## EMAIL, & TELEPHONE ORDERS

Email, & telephone orders are accepted.

Email orders to: **orders@peterpepper.com.**

Phone orders to: **800-496-0204 Ext. 7**

Mail orders to: **Peter Pepper Products, Inc.  
6525 Flotilla Street  
Commerce CA 90040**

However, if confirming purchase orders are sent, they must be marked 'CONFIRMATION'.

Duplicate orders not marked 'CONFIRMATION' are the responsibility of the customer.

## FOB POINTS

		Freight Class
<b>COMMERCE, CA 90040</b>	All products except as noted below	Class 100 - 400
<b>OSSIAN, IN 46777</b>	ReSort, GoTo Worktables, Stream	Class 100 - 150
<b>READING, PA 19601</b>	ICON Healthcare Alert Signage, Section 1.4	Class 150-400
<b>TORONTO, CANADA L1S 6N3</b>	All fiberglass products, Section 4	Class 100

## LIMITATION OF LIABILITY

Buyer's exclusive remedy for claims arising hereunder shall be for the replacement or repair of products proven to have manufacturing and/or specification defects, or the allowance of credit therefore, at the option of PPP, and shall be dependent upon PPP's acknowledgement that such defects exist. PPP's liability for any and all losses and damages to Buyer resulting from any cause whatsoever, including PPP's negligence, alleged damaged or defective goods, irrespective of whether such defects are discoverable or latent, shall be limited to the replacement or the repair of the product proven to have manufacturing and/or specification defects or allowance of credit therefore, at PPP's option.

## MISCELLANEOUS

This agreement supersedes all prior or contemporaneous written or oral representations, agreements or oral contracts. Neither party shall assign any right hereunder without the prior written approval of the other.

This agreement shall be deemed to have been made in the State of California and shall be construed in accordance with the laws thereof.

Any cause or action arising from this agreement shall be brought only in the Superior Court of the State of California in and for the County of Los Angeles, which court shall have sole and exclusive jurisdiction over all controversies arising hereunder.

## NEW ACCOUNTS/CREDIT

 American Express, Discover, MasterCard and Visa cards accepted.

New, open accounts can only be established on initial orders exceeding \$1,000 NET, accompanied by 1 bank credit and 3 trade references.

Establishing credit may take up to four weeks from date of order receipt. Allow adequate time for credit approval and production when submitting first order, or enclose payment with order.

**Non-cashier checks are held 10 days on new accounts before shipment is made.**

Returned check charge \$50.00. We may cancel or change credit terms at our discretion and may request advance payment at any time.

## Electronic Check Conversion:

When paying by check, you are authorizing Peter Pepper Products to process your check electronically. Fees may also be electronically collected from your account to cover returned items, i.e. insufficient funds.

## ALL PRICES ARE SUGGESTED LIST PRICES

Prices subject to usual trade discounts, unless otherwise specified.

**Shipping costs and any applicable taxes are additional and are not subject to discount.**

PPP is required to collect sales tax in a number of states. Valid resale certificates are accepted and will remain on file until withdrawn.

## CRATING

Charges are quoted as NET costs and are not subject to discount.

# Terms & Conditions, continued Peter Pepper Products, Inc.

PPP® Peter Pepper Products, Inc. All rights reserved.

THIS PRICE LIST SUPERSEDES ALL PREVIOUS ISSUES and is Effective January 1, 2026

## RETURNED GOODS and CANCELLATIONS

Most merchandise is manufactured to your specifications, upon receipt of your order. Therefore, no merchandise may be returned without our written consent.

Authorized returns are subject to a minimum 40% restocking charge, with a \$75 minimum.

Custom orders cannot be returned under any conditions.

Returned goods must be unused and packaged in original cartons and shipped freight prepaid within 90 days of original shipping date.

Credit is subject to inspection by our receiving department.

Orders may not be cancelled without our written consent.

A cancellation charge may be imposed at our discretion, based on the amount of production completed.

Orders ready for shipment, under no circumstances, will be cancelled.

## SHIPPING

Freight charges are pre-calculated and pre-paid by PPP and added to the original invoice at time of shipment.

All merchandise (except items marked by \*) will be shipped **UNITED PARCEL SERVICE**, unless total weight of order indicates reduced shipping charges by truck. (\$50 minimum UPS charge applies.)

When another carrier is designated by the customer, all 'Other Handling Charges', i.e. 3rd Party Pick-up and Billing, will be billed as freight charges to the customer by PPP. Freight minimums may apply.

\* **TRUCK shipment only.** (Cannot be shipped United Parcel Service) Freight will be charged at 12% of total order. \$300 minimum freight charge applies per FOB point.

**Non-cashier checks are held 10 days on new accounts before shipment is made.**

Unless complete shipping instructions are furnished by the customer, we have the option to ship by, what is in our opinion, the best way.

At our discretion, individual labeling or tagging is subject to a special handling charge.

Please be certain to include **'SHIP TO' zip code** on your order.

**Only one 'SHIP TO' address per purchase order.**

On request, Peter Pepper Products will estimate freight costs to the best of our ability. Such an estimate is not to be construed as a quotation and Peter Pepper Products assumes no responsibility for differences that may occur in the estimate and actual freight costs.

## SHORTAGE CLAIMS

Shortage claims reported after 30 days beyond shipment date will not be honored.

## SPECIALS/COLOR + STAIN MATCH

\$400 NET upcharge per color/stain match on a minimum of \$500 NET ORDER per FOB Point.

A 50% deposit is required. Custom orders for non-standard or modified products cannot be cancelled or returned under any conditions.

## COM • CUSTOMER'S OWN MATERIAL

**For complete COM instructions, see page 7.**

COM materials must be shipped freight pre-paid, with the following information on the **OUTSIDE** of the package:

1. Buyers name, Purchase Order number to PPP and date.
2. PPP Work Order number material is to cover.
3. Quantity and PPP model number material is to cover.

We cannot be held responsible for performance of COM materials, yields or variations in tone or weaving. **ALL responsibility for COM shipments is between the buyer and the source.**

## SPECIFICATIONS

PPP reserves the right to change prices, specifications, finishes and discontinue products at any time, without prior notice.

**Although some discontinued products may be shown descriptively in your edition of the catalog, model numbers and prices have been deleted from this Price List.**

Color Card approximates actual colors as closely as possible.

Color reproduction of products shown in PPP catalogs and web-site are approximate.

Actual color and/or wood samples are available on request.

Normal variations in wood finishes may occur.

Illustrations and information presented were correct when approved for printing.

## STORAGE

Orders held for 'will call' will be invoiced on date merchandise is ready for 'will call'. If delivery cannot be accepted upon agreed date, merchandise will be stored at the customer's expense and risk. Invoice for merchandise and storage will be issued when goods are placed into storage, subject to PPP standard payment terms. Storage fees of \$250 minimum plus 2% of order total will apply per week after 7 days past the ready date.

## TERMS of SALE

Payment terms are determined on a customer-by-customer and P.O. by P.O. basis. Terms will be shown on the Sales Order acknowledgment. Days are measured from Invoice Date, which is generally the Ready Date noted on the Sales Order.

**Products are shipped FOB factories. Freight is not subject to PPP trade discount.**

No anticipation discount allowed.

If payment is not made within 30 days from invoice date, customer shall be liable for interest charges of up to 1.5% per month (18% per annum) & collection costs, including attorney's fees.

## TITLE TO MERCHANDISE

Buyer acknowledges that once PPP delivers the goods to the carrier, title to the merchandise and risk of loss will pass to the buyer. If goods are damaged by the carrier while in transit, the buyer has the sole obligation of seeking any appropriate recourse against the carrier.

Peter Pepper Products shall not be liable for consequential damages.

Peter Pepper Products retains a security interest in all products sold to secure the purchase price and all other obligations owed by the customer to Peter Pepper Products until fully paid.

## WARRANTY

PPP agrees that the goods it sells will be basically as described in the PPP catalogs.

However, PPP retains the right to modify or change the composition, design, sizes and appearance of the goods, if in PPP's judgement, this is advisable.

PPP warrants that the goods it sells will be free from defects in material and workmanship for a period of three (3) years from the invoice date. All porcelain enamel writing surfaces are warranted for the lifetime of the original installation under normal atmospheric conditions.

PPP does not provide any further statement of fact, promise, representation or affirmation with respect to the quality or description of the goods it sells.

**It is expressly understood and agreed that no other express or implied warranties of any nature, including implied warranties of fitness/merchantability apply to goods sold by PPP.**

In the event a product does not conform to the foregoing warranties, the buyer's sole remedy will be for replacement or repair of parts, at PPP's option. Any warranty claim must be made promptly by written notice to PPP. Any claim not made within the warranty period is waived.

**PPP shall have no other obligation of any kind. In no event shall PPP be liable to any party for any incidental or consequential damages.**



**GREEN POLICY**

Peter Pepper Products has made environmental awareness a vital part of our business. Our mission is to meet our customers' expectations for high-design, high-quality, durable products, which also helps them meet their sustainable goals. Peter Pepper Products is committed to working towards and promoting buildings that are environmentally responsible, profitable and healthy places to live and work, while maintaining our responsibility to preserve our natural resources.

Peter Pepper Products are designed and engineered to live long, useful lives in interior and exterior environments. Most products are designed to allow for easily replaced parts. Our long-lasting, high-quality products, with low maintenance goals, translate into a more effective use of the earth's resources.

We use pre and post-consumer recycled materials, adopt environmentally sustainable processes and manufacture many products that are, themselves, recyclable or have recyclable components. We also implement our own energy efficient building solutions within our facilities, including the use of energy efficient lighting.

**CERTIFICATIONS**

- Porcelain writing surfaces are GREENGUARD Certified for Children & Schools.
- Laminates are GREENGUARD certified.
- Adhesives for lamination are GREENGUARD Certified, 3M 94 CA, which conforms with SCAQMD, California State Law and LEED EQc4.1.
- Substrates: Fiberboard-MDF-Melamine w/particle board core are NAUF CARB 1 compliant.
- Polyurethane Paint: 2.8 lbs VOC per gallon, Pigment and clear lacquer, 2.0 VOC per gallon.
- Starphire®: This ultra clear glass possesses a Silver Level, Cradle to Cradle certification issued by McDonough Braungart Design Chemistry, LLC. (MBDC)

**RECYCLED CONTENT**

Peter Pepper Products is in the process of developing Product Environmental Profiles for Certifications and LEED Contribution for recycled content, regional materials and low emitting materials from our suppliers.

- Metals are the world's most highly recycled material and can be 100% recyclable. Many of our products are primarily formed of steel and aluminum. The recycled content of these metals are consistent with the industry standard up to 60% Post Consumer and 40% Pre-Consumer.
- HDPE is 100% recyclable through a re-grinding process with similar products.
- ABS and base sheets are 100% recyclable through a re-grinding process with similar products.
- Terratex®: Developed by Guilford of Maine, Terratex® fabrics are made from 100% post and pre-consumer recycled polyester, or compostable material using increasingly sustainable manufacturing practices to produce a high quality product that is recyclable at the end of its useful life.
- Packaging materials contain 30% - 100% post-consumer waste including corrugated packing boxes containing a minimum of 30% recycled content, starched base biodegradable packing pellets, wooden crates, chip board, and shredded paper containing 90% - 100% recycled content.



Terratex is a registered trademark of True Textiles, Inc. and designates fabrics that are made from 100% recycled or compostable material using increasingly sustainable manufacturing practices to produce a high quality product that is recyclable at the end of its useful life. [www.terratex.com](http://www.terratex.com)

© 11/2024

**Finishes & Fabrics**

**PPP Solid Wood, Veneer or Laminate**

**Wood Finishes**

- CH** Cherry
- LC** Light Cherry
- HO** Honey
- MA** Natural Maple
- MM** Mahogany
- LW** Light Walnut
- W** Walnut

**Laminate/Melamine Cross Reference**

- Wilsonart® 7924-07 Biltmore Cherry
- Wilsonart® 7919-38 Amber Cherry
- Pionite WM951-S Honey Maple
- Wilsonart® 7909-60 Fusion Maple
- Wilsonart® 7922-07 Brighton Walnut
- Wilsonart® 7937-38 River Cherry
- Lamin-Art 2608-T Fancy Walnut

**Section 1/1.1: Express Desk Door Front Laminate**

- Soft White WA 1572-60
- Cool Grey WA D381-60
- Maple WA 7909-60

**Fabrics**

**Guilford of Maine**

To order samples, visit online sample service: <http://www.guilfordofmaine.com>



**Sprite Style 2671**

- 010 Linen 030 Khaki
- 020 Butter 032 Harvest
- 031 Kiwi 040 Snow
- 012 Sherbet

**Lido Style 2858**

- 024 Oak Bluffs 023 Cape May
- 010 Hermosa 030 Newport
- 065 Bryce Canyon 031 Smith Point
- 019 Balboa

**Crosstown Style 2526**

- 010 Cement 040 Waterfront
- 030 Ray 060 Fieldstone
- 070 Stucco 080 Buff
- 021 Graphite

COM: Customer's Own Material

**Cork**

**Natural Cork**

**ColorCork<sup>1</sup> - Forbo Linoleum, Inc.**

- 2186
- 2187
- 2209

**ColorCork Specifications<sup>1</sup>**

- ColorCork is made from pure, granulated cork and natural ingredients that are combined under heat and pressure to create a smooth, suede-like surface of exceptional durability.
- ColorCork is washable, tackable and reseals itself after push-pins are removed. The cork naturally inhibits bacterial growth and is environmentally friendly with no toxins or harmful by-products or emissions.
- The ColorCork surface does not crack, peel or crumble and has low light reflectance.
- Meets ASTM E-84, class B and NFPA 253, Class II.

Samples available on request via Forbo Linoleum, Inc., 800-842-7839 x 712.

**COM - Customer's Own Material**

Optional COM - Customer's Own Materials are available on most tackable panels.

**Shipping Instructions for COM**

When ordering material, customer must have supplier of material mark the following information on the outside of the package.

1. Buyer's name.
2. Purchase Order Number to PPP.
3. Purchase Order date.
4. Work Order Number material is to cover.
5. Quantity and model number(s) material is to cover.
6. Specify fabric direction: conventional or railroad.

**All materials to be shipped FREIGHT PREPAID to:**

Peter Pepper Products, Inc., 6525 Flotilla Street, Commerce CA 90040.

**Responsibility for COM shipments:**

- We cannot be held responsible for performance of COM covering materials, nor shall we be held responsible for yields or variations in tone or weaving.
- All responsibility for COM shipments is between the buyer and the source.

© 11/2024



PRICE LIST & SPECIFICATIONS

Effective January 1, 2026

All Prices are Suggested List Price

Updated 11.03.25

- Mode Tables
- Stream Wastebaskets + Recycling
- Clocks
- GoTo Worktables
- MeetUp
- ClinArt Writing Surfaces
- ReForm Waste + Recycling
- Receptacles
- ReSort Waste + Recycling Receptacles

**Stream**  
**Wastebaskets & Recycling**  
*Design by Peter Stathis*

Model	Description	Size	Capacity	List	Est. Ship Weight
SW	Deskside recycling wastebasket - single stream, no top	17"w x 15 1/2"h x 9"d	6.8gal	\$456	16*
SW1	Deskside recycling wastebasket - single stream with top Top: (1) 5 1/2" x 14" opening, aluminum w/ powdercoat finish to match interior	17"w x 15 1/2"h x 9"d	6.8gal	\$555	16*
SW2	Deskside recycling wastebasket - dual stream with top Top: (2) 5 1/2" x 5 1/2" openings, aluminum w/ powdercoat finish to match interior	17"w x 15 1/2"h x 9"d	3.4gal ea.	\$555	16*
SRT	Tall recycling station - dual stream Top: (2) 7" x 10" openings, aluminum w/ powdercoat finish to match interior	30"w x 25 3/4"h x 12"d	3.4gal ea.	\$1,143	80*

Shipped by Truck\* FOB Indiana



SW



SW1



SW2



SRT

©11/2024

©11/2024

**To Order Specify**

<ol style="list-style-type: none"> <li>1. Quantity</li> <li>2. Model</li> <li>3. Exterior Finish</li> <li>4. Interior Finish</li> <li>5. Recycling Decal Specify color: White or Graphite</li> </ol>	<b>Exterior Finishes</b> Bright White Graphite Aluminum Metallic Taupe Metallic Pacific Blue Poppy	<b>Interior Finishes</b> Bright White Graphite Aluminum Metallic Taupe Metallic Pacific Blue Poppy
<i>See Web</i>		

**Specifications**

- SW, SW1, SW2: (2) exterior aluminum panels surround aluminum inner waste/recycling receptacle. Powder coat finish.
- SRT: (2) exterior aluminum panels surround the steel inner waste/recycling receptacle. Powder coat finish.
- Bag Retainer: Internal bag retainers and drip pan furnished. Bag retainer conceals bag folded over lip.
- SW1, SW2, and SRT Top: Aluminum with powder coat finish, same as interior finish. Top conceals bag.
- Includes Recycling and Waste decals in White or Graphite.



**Liner Bags**

Model	Bag Size	Capacity (Gallons)	Uline Model	Quantity Per Unit
SW	20" X 20"H	7	S-1742	1
SW1	20" X 20"H	7	S-1742	1
SW2	16" X 20"H	4	S-1354	2
SRT	20" x 36"H	12-16	S-3114	2

Model numbers shown are for Uline brand bags (Uline.com). Bag sizes are approximate and can be sourced from other manufacturers.



# Clocks

820 • 835

Design by Joe Ricchio and Eric MacDonald



820  
Shown with Face Number 36

820 Clock				Est. Ship Weight
Model	Description	Size	List	
820	With flush Acrylic Cover	13 7/8" dia x 1 5/8" d	\$348	5

 Available with SyncTech® Wireless Time, see website for specifications.....Upcharge \$588 List

### Faces for Model 820 Only



To Order Specify	
1. Quantity	<b>Bezel Finish</b> <b>A</b> PPP Color See PPP Color Card or Web
2. Model	
3. Bezel Finish	
4. Clock Face Number (select face number)	

### Specifications

- Bezel available in any PPP Color.
- Quartz battery movement.
- Red sweep second hand included.

835 Clock				Est. Ship Weight
Model	Description	Size	List	
835	Clear acrylic Clock with black surface graphics	14" dia x 1" d	\$206	3

All clocks: FOB Commerce

To Order Specify	
1. Quantity	
2. Model	

### Specifications

- Surface graphics on 1/8" clear acrylic face.
- Quartz battery movement.
- Red sweep second hand included.

Please see Section 2/2a for additional clock models.

# Tables

PickUp



PickUp



PickUp  
Four tables, grouped

PickUp Table Design by Andrea Ruggiero				Est. Ship Weight
Model	Description	Size	List	
PICKUP	Stackable Table	18 1/2" w x 23" h x 13 1/2" d	\$610	12

Orders of 3 or more units will ship via truck. See freight rates below. FOB Indiana

### To Order Specify

1. Quantity	<b>Base Finishes</b> Bright White                      Green Graphite                              Burnt Orange Aluminum Metallic Taupe Metallic See PPP Color Card or Web	<b>Top Finishes</b> White - Compact HPL (Formica Matte 459-58) Aluminum Metallic, Taupe Metallic, Green, Orange, - Paint See Textures & Finishes Card or Web
2. Model		
3. Base Finish		
4. Top Finish		

### Specifications

- Base: Aluminum, laser cut and formed. Bright White, Graphite, Aluminum Metallic, Taupe Metallic – textured powder coat finish. Green, Orange, Yellow – polyurethane finish.
- Top: Compact HPL, 1/2", laminate on 1/2" multi-ply core, or paint on 1/2" MDF.
- Cutout detail acts as carrying handle/wire management.



©11/2024

©11/2024

# GoTo Worktables

## Wall Mounted

Design by Eric Pfeiffer

NEX

Model	Description	Size	List	Est. Ship Weight
GTW36	Wall Mounted Worktable	36"w x 7 1/2" h x 13 3/8" d	\$1,359	72*
GTW48	Wall Mounted Worktable	48"w x 7 1/2" h x 13 3/8" d	\$1,693	106*
GTW60	Wall Mounted Worktable	60"w x 7 1/2" h x 13 3/8" d	\$1,917	153*
GTR36	Wall Mounted Worktable	36"w x 40" h x 13 3/8" d	\$1,910	108*
GTR48	Wall Mounted Worktable	48"w x 40" h x 13 3/8" d	\$2,261	152*
GTR60	Wall Mounted Worktable	60"w x 40" h x 13 3/8" d	\$2,592	210*



GTW60



GTR36



Optional Electrical Module

### Options

#### Electrical Module

Each module contains (2) 120v, 15 amp receptacles and (2) USB charging ports (A+C), 2100mA 5V/DC. Includes 8' wire drop, 14/3 gauge with grounded plug.  
 GTF Models: Accommodates 2 modules on each side. Specify 1, 2, 3 or 4 modules.  
 Wire drop is concealed in a wire channel that extends down the left or right inside face of the freestanding base, with an additional 4' of cord at the floor.  
 If no electrical modules are ordered, a cover face plate conceals cut out.

\$598

3

Shipped by Truck\* Shipped in 2 boxes<sup>2)</sup>  
 Shipped KD  
 FOB Indiana

### To Order Specify

1. Quantity	<b>Frame, Aluminum Top &amp; Wall Panel Finishes</b> Bright White Graphite Aluminum Metallic Taupe Metallic <i>See PPP Color Card or Web</i>
2. Model	
3. Frame Finish	
4. Top Finish	
5. Wall Panel Finish (Model GTR)	
6. Option	

### Specifications

- Frame: Steel, with powder coat finish. Includes 2 hooks.
- Top: Aluminum 1/4" with powder coat finish.
- Wall Panel (Models GTR36, GTR48 & GTR60): Conceals electrical wiring. 1/4" MDF with laminate finish. Velcro® attachment.

©11/2024

©11/2024



# MeetUp

## Mobile Easel & Wall Writing Surfaces

Design by Eric Pfeiffer

NEX

MeetUp Mobile Easel		Size	List	Est. Ship Weight
ME36	Double-Sided Mobile Easel - (2) 36"w x 44" h Steel Writing Surfaces, 36"w x 73"h x 28"d 36"w x 26" h Storage Base		\$3,119	210*



ME36 - MeetUp Mobile Easel

Shipped by Truck\* FOB Commerce

### To Order Specify

1. Quantity	<b>Base Finishes</b> Bright White Graphite Aluminum Metallic Taupe Metallic <i>See PPP Color Card or Web</i>
2. Model	
3. Base Finish	

### Specifications

- Writing Surface: Steel, magnetic, with a premium quality polyurethane powder coating that provides a high quality dry-erase finish. Extremely smooth and tough, resistant to chemicals and solvents.
- Storage Base: Steel with powder coat finish.
- Shelves: 2.
- 3" locking casters.
- Four dry erase markers and eraser included.
- Writing surface accepts magnetic accessories.



# ClinArt Glass Writing Surface With Removable Graphic Board

NEX

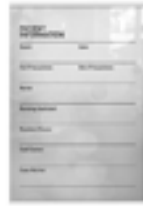

RG2436  
Shown with removable graphic board  
(Customer's Own or PPP printed).



RG3624  
Shown with removable graphic board  
(Customer's Own or PPP printed).



RGPH2  
Optional Marker and Eraser Holder

Model	Description	Size	Clear (no graphic supplied)	Starphire® (no graphic supplied)	PPP Printed Graphic Board Upcharge	Unprinted Graphic Board Upcharge	Est. Ship Weight
<b>Vertical</b>							
RG1824	Glass Writing Surface w/ removable graphic board	18"w x 24"h x 1/2"d	\$342	\$483	\$123	\$36	18^
RG2436	Glass Writing Surface w/ removable graphic board	24"w x 36"h x 1/2"h	\$488	\$693	\$190	\$68	28^
<b>Horizontal</b>							
RG2418	Glass Writing Surface w/ removable graphic board	24"w x 18"h x 1/2"d	\$342	\$483	\$123	\$36	18^
RG3624	Glass Writing Surface w/ removable graphic board	36"w x 24"h x 1/2"h	\$488	\$693	\$190	\$68	28^

### Set Up Fee for Printed Graphic Board

Digitally printed on 2mm Sintra from customer's supplied artwork.

#### ARTWORK REQUIREMENTS:

Vector graphics at 150 DPI, CMYK color mode. All fonts and links embedded.  
File Formats: PDF, EPS, AI, and TIFF.

Set up fee per order and/or per graphic change (not included in above prices) \$261

### Option

RGPH2	Marker and eraser holder. Holds 2 markers and 1 eraser. Accessories not included. Double sided tape included.	7"w x 2 3/4"h x 2"d	\$39
-------	--	---------------------	------

^UPS Dimensional Weight FOB Commerce

Removable Graphic Board slides left or right  
and is easy to replace



### To Order Specify

<ol style="list-style-type: none"> <li>Quantity</li> <li>Model</li> <li>Frame Finish</li> <li>Printed Graphic Board Quantity</li> <li>Option</li> </ol>	<b>Frame Finishes</b> Bright White Aluminum Metallic Taupe Metallic <i>See PPP Color Card or Web</i>
---	--

### Specifications

- Model RG Clear: Tempered glass surface, 1/8" thick, slight green tint in appearance, with pencil polish edges.
- Model RG Starphire®: Tempered glass surface, 1/8" thick. Low iron content produces clear edges and crystal clear in appearance. With pencil polished edges.
- Removable graphic board slides in from either side. Graphic board should not exceed 2mm or 3/32" thickness. For customer's own graphic board, contact factory for dimensions.
- Frame: Steel with powder coat finish.
- Wall mount cleat/bracket and hardware included.
- Two dry erase markers and one eraser included with each ClinArt writing surface.



# Waste and Recycling Receptacles Tilt

NEX



TL-T

TL-S

### Tilt Waste Receptacle *Design by Eric Pfeiffer*

Model	Description	Size	Capacity	Aluminum Metallic	Stainless Steel	Est. Ship Weight
TL-T	Top Opening: 10" diameter	20"dia x 43"h	30 gal	\$2,551	\$3,450	54*
TL-S	Side Opening: 18"w x 6 1/2"h	20"dia x 47"h	30 gal	\$2,596	\$3,497	55*

### Options

Security Mounting Kit. For concrete, includes "L" brackets and concrete anchors. \$89 4

Replacement Recycling & Waste Decals, Set of 10. In White or Graphite. \$36

Includes text labels for "waste", "recycle", "aluminum", "plastic", "glass", "paper", "compost", "commingle" and

Shipped by Truck\* FOB Commerce

### To Order Specify

- Quantity
- Model
- Finish
- Recycling Decal. Specify color: White or Graphite
- Options

#### Finishes

Aluminum Metallic  
SS Stainless Steel

*See PPP Color Card or Web*

### Specifications

- Steel, Aluminum Metallic powder coat finish or brushed Stainless Steel 304 - #4 finish. Height of steel can only, 36" without top.
- Graphite Top: Roto-molded polyethylene.
- Polyethylene liner included.
- Powder coat finishes are intended for indoor use only. For outdoor applications, please select Stainless Steel.
- Includes Recycling and Waste decals, in White or Graphite.

©11/2024

©11/2024



# Waste and Recycling Receptacles

## ReForm • Top & Front Loading

Design by Christopher Panichella



Top Loading		Container Capacity (gallons)	Laminate	Est. Ship Weight	
<b>Model</b>	<b>Description</b>	<b>Size</b>			
RF24	Top Openings: (2) 8" w x 11" d	24" w x 32" h x 22" d	23 gal (x2)	\$1,955	117*
RF36	Top Openings: (3) 8" w x 11" d	36" w x 32" h x 22" d	23 gal (x3)	\$2,407	169*
RF48	Top Openings: (4) 8" w x 11" d	48" w x 32" h x 22" d	23 gal (x4)	\$2,994	203*
Replacement Recycling & Waste Decals, Set of 10. In White or Graphite.				\$36	
Lockable Casters - 2"				\$333	

Shipped by Truck\* FOB Commerce

To Order Specify		
<ol style="list-style-type: none"> <li>Quantity</li> <li>Model</li> <li>Cabinet Panel Finish</li> <li>Top Finish</li> <li>Decals. Specify color: White or Graphite</li> <li>Options</li> </ol>	<b>Cabinet Panel Finishes</b> Formica Twill - Matte Neutral 8826-58 Earthen 8828-58 Graphite 8829-58 <i>See Textures &amp; Finishes Card or Web</i>	<b>Top/Tray Finishes</b> Soft White Aluminum Metallic <i>See PPP Color Card or Web</i>

### Specifications

- Suitable for recycling paper, cans, glass, plastic and waste.
- Cabinet Panels: Melamine.
- Top: Steel, powder coat finish in Soft White or Aluminum Metallic.
- Doors: (1) hinged door on 24" w models; (2) hinged doors on 36" w and 48" w models.
- Polyethylene liners included, one per opening.
- Adjustable foot glides included.
- Includes a set of 11 decals in White or Graphite: recycling and waste symbols, and text Waste | Recycle | Landfill | Aluminum | Plastic | Glass | Paper | Compost | Commingle

Front Loading		Container Capacity (gallons)	Laminate	Est. Ship Weight	
<b>Model</b>	<b>Description</b>	<b>Size</b>			
RFF36	Front Openings: (3) 9" w x 7" d	36" w x 41" h x 22" d	23 gal (x3)	\$3,252	209*

### Options

- Replacement Recycling & Waste Decals, Set of 10. In White or Graphite. \$36
- Lockable Casters - 2" \$333

Shipped by Truck\* FOB Commerce

To Order Specify		
<ol style="list-style-type: none"> <li>Quantity</li> <li>Model</li> <li>Cabinet Panel Finish</li> <li>Top Finish</li> <li>Recycling Decal. Specify color: White or Graphite</li> <li>Options</li> </ol>	<b>Cabinet Panel Finishes</b> Formica Twill - Matte Neutral 8826-58 Earthen 8828-58 Graphite 8829-58 <i>See Textures &amp; Finishes Card or Web</i>	<b>Top Finishes</b> Soft White Aluminum Metallic <i>See PPP Color Card or Web</i>

### Specifications

- Suitable for recycling paper, cans, glass, plastic and waste.
- Cabinet Panels: Melamine.
- Top: Steel, powder coat finish in Soft White or Aluminum Metallic.
- Doors: (2) hinged doors.
- Polyethylene liners included, one per opening.
- Adjustable foot glides included.
- Includes a set of 11 decals in White or Graphite: recycling and waste symbols, and text Waste | Recycle | Landfill | Aluminum | Plastic | Glass | Paper | Compost | Commingle

# Waste and Recycling Receptacles

## ReSort

Design by Joe Ricchio & Eric MacDonald



Top Loading		Container Capacity (gallons)	List	Est. Ship Weight
<b>Model</b>	<b>Description</b>	<b>Size</b>		
RS14	Top Opening. Hinged Door.	14" w x 38" h x 20" d	\$2,024	75*
RS20	Top Opening. Hinged Door.	20" w x 38" h x 20" d	\$2,353	128*

### Options

- Security Mounting Kit. For concrete, includes "L" brackets and concrete anchors. \$89 4
- Replacement Recycling & Waste Decals, Set of 10. In White or Graphite. \$36
- Includes text labels for "waste", "recycle", "aluminum", "plastic", "glass", "paper", "compost", "commingle" and Lockable Casters - 2" \$333

Shipped by Truck\* FOB Indiana

(2) RS14 and (1) RS20



### To Order Specify

<ol style="list-style-type: none"> <li>Quantity</li> <li>Model</li> <li>Top &amp; Body Finish</li> <li>Door Finish</li> <li>Top Opening Name</li> <li>Recycling Decal. Specify color: White or Graphite</li> <li>Options</li> </ol>	<b>Top &amp; Body Finishes</b> Graphite Aluminum Metallic Taupe Metallic	<b>Door Finishes</b> Bright White Soft White Graphite Aluminum Metallic Taupe Metallic	<b>Top Openings</b>  Waste 8" x 10"  Cans & Glass 10" x 4 1/2"  Paper 1 1/4" x 3"  Commingled Recyclables 11 5/8" x 55" dia. x 3" <i>See PPP Color Card or Web</i>
---	---	---	---

### Specifications

- Suitable for recycling Paper, Cans, Glass, Plastic and Waste.
- Dimensions: 38" h in back, 32" h in front.
- Body, Top and Door: Steel, powder coat finish.
- Door: Hinged on right side.
- Polyethylene liner included.
- Adjustable foot glides included.
- Indoor use only. For exterior applications, please contact Customer Service.
- Includes text and graphics Recycling and Waste decals in White or Graphite.



# Waste and Recycling Receptacles

## ReMix

Design by Andrea Ruggiero

**NEX**



Duo  
Shown with D3 Top Opening



Trio-S  
Shown with T1 Top Opening

Model	Description	Size	Container Capacity (gallons)	List	Est. Ship Weight
DUO-S	Waste and Recycling Receptacle with Steel Sides	38"w x 30"h x 11"d	13gal + 13gal	\$1,359	75*
TRIO-S	Waste and Recycling Receptacle with Steel Sides	55"w x 30"h x 11"d	13gal + 13gal+ 13 gal	\$2,121	105*

Shipped by Truck\* FOB Commerce



**PRICE LIST & SPECIFICATIONS**

Effective January 1, 2026

All Prices are Suggested List Price

Updated 11.03.25

**To Order Specify**

<ol style="list-style-type: none"> <li>Quantity</li> <li>Model</li> <li>Side Finish</li> <li>Top Opening Code: D3 or D4 for Duo Models; T1 for Trio-S Model</li> </ol>	<p><b>Side Finishes</b></p> <p>Graphite Aluminum Metallic Taupe Metallic</p> <p><i>See PPP Color Card or Web</i></p>	<p><b>Top Opening Configurations &amp; Ordering Codes</b></p> <div style="display: flex; justify-content: space-around;"> <div style="text-align: center;"> <p><b>D3</b></p>  <p>12½ x 4¼ x 2 Commingled Recyclables</p> </div> <div style="text-align: center;"> <p><b>D4</b></p>  <p>11 x 7    11 x 7 Waste    Multi-Stream Waste</p> </div> </div> <div style="text-align: center; margin-top: 20px;"> <p><b>T1</b></p>  <p>12½ x 4¼ x 2    11¾ x 7    11¾ x 7 Commingled    Waste    Waste Recyclables</p> </div>
--	--	---

**Specifications**

- Suitable for single and multi-stream recycling and waste management.
- Steel sides and hinged door, powder coat finish.
- Top: 1" MDF (formaldehyde free), Graphite powder coat finish.
- Polyethylene liners included: 2 with Duo, 3 with Trio.
- Each unit includes (9) decals: Waste, Recycling Only, Paper Only, Bottles Only, Glass Only, Aluminum Only, Plastic Only, Gloves Only, Masks Only
- Indoor use only.



© 11/2024

© 11/2024



OSHPD Seismic Compliant  
Anchorage in California

# 4100 Magazine Racks, File & Chart Holders

Designed by Joe Ricchio

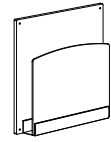

4101

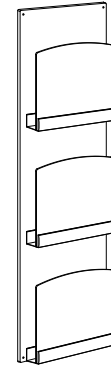

4103

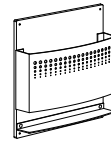

4111  
Dots

Model	Description	Size	Front Panel	Frosted Green	Quattro Platinum or Carbon	Est. Ship Weight
4101	1 Pocket	14"w x 14"h x 2 1/2"d	12 1/2"w x 7 1/2"h	\$143	\$221	6
4101H	1 Pocket HIPAA	14"w x 14"h x 2 1/2"d	12 1/2"w x 10"h	\$187	\$267	6
4103	3 Pocket	14"w x 42"h x 2 1/2"d	12 1/2"w x 7 1/2"h	\$430	\$662	18

### To Order Specify

<ol style="list-style-type: none"> <li>Quantity</li> <li>Model</li> <li>Back Panel: Textured PPP Color</li> <li>Front Panel: Quattro Platinum, Carbon or Frosted Green</li> </ol>	<b>Back Panel</b> A PPP Color	<b>Front Panel</b> Quattro Platinum Quattro Carbon Frosted Green
---	----------------------------------	---

### Specifications

- Front panel available in 3form®: Quattro Platinum, Quattro Carbon, or Frosted Green Acrylic.
- Back panel in any Textured PPP Color.
- Shelf Trim: Natural Anodized Aluminum.
- Nominal pocket ID: 13/4"d.
- Screw mount.

Model	Description	Size	Front Panel	List	Est. Ship Weight
4111	1 Pocket	14"w x 14"h x 3"d	14"w x 8 1/2"h	\$238	7
4111H	1 Pocket HIPPA	14"w x 14"h x 3"d	14"w x 10"h	\$238	7

### Pocket Styles

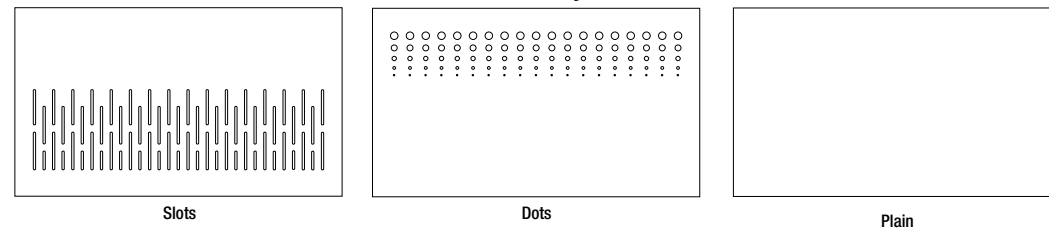

### To Order Specify

<ol style="list-style-type: none"> <li>Quantity</li> <li>Model</li> <li>Back Panel: Textured PPP Color</li> <li>Front Panel Style: Slots, Dots, or Plain</li> <li>Front Panel: PPP Color</li> </ol>	<b>Back Panel</b> A PPP Color	<b>Front Panel</b> A PPP Color
---	----------------------------------	-----------------------------------

*See PPP Color Card or Web*

### Specifications

- Curved steel front panel and shelf in any PPP Color.
- Back panel in any Textured PPP Color.
- Nominal pocket ID: 2"d.
- Screw mount.

# 4100 Magazine Racks, File & Chart Holders

Designed by Joe Ricchio

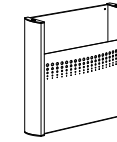

4121  
Dots

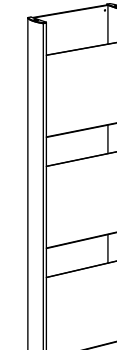

4123  
Plain

Model	Description	Size	Front Panel	List	Est. Ship Weight
4121	1 Pocket	14"w x 14"h x 2 1/2"d	13"w x 7 1/2"h	\$236	8
4123	3 Pocket	14"w x 42"h x 2 1/2"d	13"w x 7 1/2"h	\$604	22

### Pocket Styles

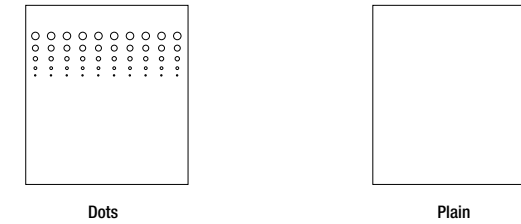

### To Order Specify

<ol style="list-style-type: none"> <li>Quantity</li> <li>Model</li> <li>Back Panel: PPP Color</li> <li>Front Panel Style: Dots or Plain</li> <li>Front Panel: PPP Color</li> </ol>	<b>Back Panel</b> A PPP Color	<b>Front Panel</b> A PPP Color
--	----------------------------------	-----------------------------------

*See PPP Color Card or Web*

### Specifications

- Steel front and back panel in any PPP Color.
- Lift up front panel for cleaning.
- Side Frames: Natural Anodized Aluminum.
- Nominal pocket ID: 21/4"d.
- Screw mount.



© 11/2024

© 11/2024



# 4100 Magazine Racks, File & Chart Holders

Designed by Joe Ricchio

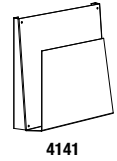

4141

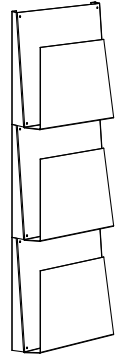

4143

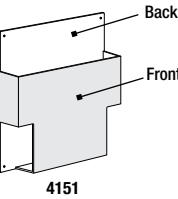

4151

Model	Description	Size	Front Panel	List	Est. Ship Weight
4141	1 Pocket	14"w x 14"h x 3 7/8"d	12 1/2"w x 7 1/2"h	\$158	5
4141H	1 Pocket HIPAA	14"w x 14"h x 3 7/8"d	12 1/2"w x 10"h	\$171	5
4143	3 Pocket (Each pocket mounts individually)	14"w x 14"h x 3 7/8"d	12 1/2"w x 7 1/2"h	\$428	17

### To Order Specify

- Quantity
- Model
- Finish

#### Finish

A PPP Color

See PPP Color Card or Web

### Specifications

- One-piece, steel rack in any PPP Color.
- Nominal pocket ID: 13/4"d.
- Sloping back panel stands off wall 3/4" at top, 2" at bottom.
- Keyhole mount.
- **Note:** For multiple racks, each pocket mounts individually.

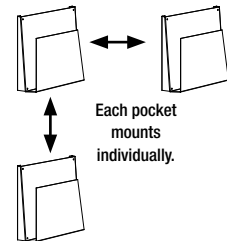

Model	Description	Size	Front Panel	List	Est. Ship Weight
4151	1 Pocket	12 1/2"w x 12 1/2"h x 2 1/2"d	12 1/2"w x 7 1/2"h	\$216	5
4151H	1 Pocket HIPAA	15"w x 12 1/2"h x 2 1/2"d	15"w x 10"h	\$243	5

### To Order Specify

- Quantity
- Model
- Finish

Front Brushed Stainless / Back White

See PPP Color Card or Web

### Specifications

- One-piece, Dibond® rack, two-sided. Aluminum face with polyethylene core, 3mm.
- Nominal pocket ID: 21/4"d.
- Screw mount.
- **Note:** For multiple racks, each pocket mounts individually.

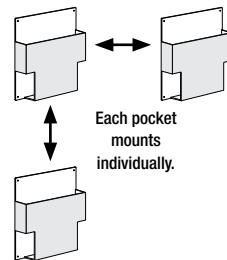

# 4001 - 4006 Magazine Racks, File & Chart Holders

Designed by Joe Ricchio



4001 Holes

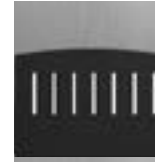

4003 Slots

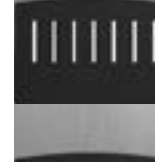

4003 Holes

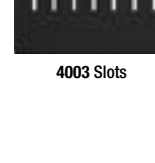

4003 Squares

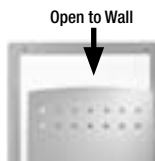

4006H Squares

Model	Description	Size	Front Panel	Textured PPP Color	Wood Veneer	Est. Ship Weight
4001	1 Pocket	12 3/4"w x 14"h x 2"d	10"w x 7"h	\$140	\$215	6^
4001H	1 Pocket HIPAA	12 3/4"w x 14"h x 2"d	12 1/2"w x 10"h	\$187	\$321	7^
4001HXL	1 Pocket HIPAA	12 3/4"w x 14"h x 4"d	12 1/2"w x 10"h	\$206	\$281	9^
4002	2 Pocket	12 3/4"w x 26"h x 2"d		\$281	N/A	12^
4003	3 Pocket	12 3/4"w x 39"h x 2"d		\$418	N/A	17^

^ UPS Dimensional Weight

### Panel Styles



Slots



Holes



Squares

### To Order Specify

- Quantity
- Model
- Back Panel:

Textured PPP Color (All Models)  
Wood Veneer Finish (Models 4001, 4001H, 4001HXL)

- Front Panel Style: Slots, Holes or Squares
- Front Panel: PPP Color

#### Finishes

A	PPP Color	MA	Natural Maple
CH	Cherry	MM	Mahogany
LC	Light Cherry	LW	Light Walnut
HO	Honey	W	Walnut

See PPP Color Card or Web

### Specifications

- Steel front panel available in any PPP Color.
- Nominal Pocket ID: 11/2"d.
- Screw mount.

Model	Description	Size	Front Panel	List	Est. Ship Wt.
4006H	1 Pocket, Squares HIPAA	12 1/2"w x 15 1/2"h x 2"d	10"w x 10" h	\$209	6

### To Order Specify

- Quantity
- Model
- PPP Color

A PPP Color

See PPP Color Card or Web

### Specifications

- 1 piece, 18 gauge steel rack. Available in any PPP Color.
- Back of rack open to wall.
- Nominal Pocket ID: 11/2"d.
- Screw mount.
- **Note:** For multiple racks, each pocket mounts individually.

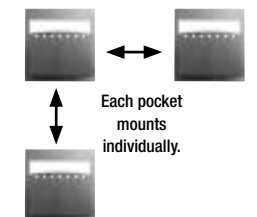

© 8/2022 © 11/2024

© 11/2024



# 4081 - 4083 Magazine Racks, File & Chart Holders

Designed by John Caldwell



4083

Model	Description	Size	Textured PPP Color	Wood Veneer	Est. Ship Weight
4081	1 Pocket	12 3/4"w x 14"h x 2 1/2"d	\$222	\$297	8^
4082	2 Pocket	12 3/4"w x 26"h x 2 1/2"d	\$444	\$587	16^
4083	3 Pocket	12 3/4"w x 39"h x 2 1/2"d	\$664	\$860	24^

^ UPS Dimensional Weight

### Specifications

- Steel front pocket in any PPP Color.
- Back panel available in any Textured PPP Color or Wood Veneer Finish.
- Nominal Pocket ID: 12 3/4" w x 9" h x 2" d.
- Keyhole mount.

### To Order Specify

1. Quantity	<b>Finishes</b>	
2. Model	A PPP Color	MA Natural Maple
3. Back Panel: Textured PPP Color or Wood Veneer Finish	CH Cherry	MM Mahogany
4. Pocket/Panel Finish: PPP Color	LC Light Cherry	LW Light Walnut
	HO Honey	W Walnut
	<i>See PPP Color Card or Web</i>	

© 5/2022 © 11/2024

© 11/2024



# 480P Magazine Racks

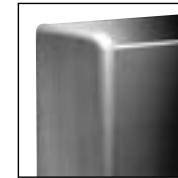

480P Edge Detail



DV480

Model	Description	Size	List	Est. Ship Weight
481	7 Pocket High with Acrylic Front Panels	14"w x 51 1/2"h x 4"d	\$1,106	22^
482P	4 Pocket High with Acrylic Front Panels	14"w x 30 1/4"h x 4"d	\$684	12^
483P	3 Pocket Horizontal with Acrylic Front Panels	40"w x 23"h x 4"d	\$1,035	25^
484P	3 Pocket High with Acrylic Front Panels	14"w x 23"h x 4"d	\$566	12^
488P	1 Pocket with Acrylic Front Panels	14"w x 14 1/2"h x 4"d	\$300	8^
<b>Option</b> DV480	Pocket Divider, Clear Acrylic	7 3/4"h x 1 1/4"d	\$32	1

^ UPS Dimensional Weight



481P  
7 Pocket



482P  
4 Pocket

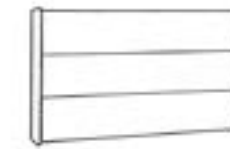

483P  
3 Pocket Horizontal



484P  
3 Pocket

### To Order Specify

1. Quantity	<b>Finishes</b>	
2. Model	A PPP Color	MM Mahogany
3. Side Panels: Wood Finish or PPP Color	CH Cherry	LW Light Walnut
4. Back Panel: PPP Color	LC Light Cherry	W Walnut
5. Option	HO Honey	MA Natural Maple
	<i>See PPP Color Card or Web</i>	

### Specifications

- 7 1/2" h clear acrylic front panel.
- Back Panels available in any PPP Color.
- Nominal pocket ID: Vertical Models: 12 1/4" w x 13" h x 11 1/4" d  
Horizontal Models: 38 1/4" w x 13" h x 11 1/4" d  
1 Pocket Models: 12 1/4" w x 13" h x 2 7/8" d
- Eyelet hanger mount.



# 600 Magazine & Literature Racks

## Multiple Pockets



# Freestanding Magazine & Literature Racks

## Double Sided & Rotating

Model	Description	Size	List	Est. Ship Weight
600	10 Pocket Vertical	19 1/2"w x 63"h x 3"d	\$1,245	25*
602	4 Pocket Vertical	19 1/2"w x 25 1/2"h x 3"d	\$600	12^
603	5 Pocket Horizontal	48"w x 13"h x 3"d	\$701	17^
604	5 Pocket Vertical	10"w x 63"h x 3"d	\$755	17^
605	9 Pocket Vertical	29"w x 38"h x 3"d	\$1,089	24*
606	10 Pocket Vertical - 8 pockets Literature Size or 2 Pockets Magazine Size	19 1/2"w x 38"h x 3"d	\$964	17*
<b>Options</b>				
609	Pocket Divider, Clear Acrylic	6"h x 2"d	\$28	1
610	Paper Stop, Clear Acrylic	9"h x 2"h	\$24	1
612	Pocket Divider & Paper Stop, Clear Acrylic	6"h x 2"d	\$40	1

^UPS Dimensional Weight Shipped by Truck\*



600



602



603

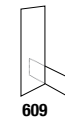

609

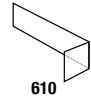

610



612



604



605

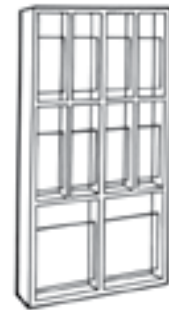

606

### To Order Specify

1. Quantity	<b>Finishes</b>	
2. Model	CH Cherry	MM Mahogany
3. Frame: Wood Finish	LC Light Cherry	LW Light Walnut
4. Back Panel: PPP Color	HO Honey	W Walnut
5. Options	MA Natural Maple	

See PPP Color Card or Web

### Specifications

- Frame: Wood Finish.
- Back panel available in any PPP Color.
- Front pocket panels are 7'h clear acrylic.
- Nominal pocket ID: 9"w x 12"h x 21/2"d. Model 606: 4 1/2"w x 12"h x 21/2"d and 9"w x 12"h x 21/2"d.
- Eyelet mount.

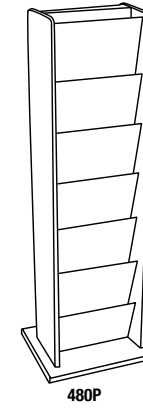

480P

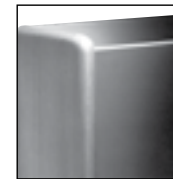

480 Edge Detail

Model	Description	Size	List	Est. Ship Weight
480P	7 Pocket High, with Acrylic Front Panels each side	14"w x 53"h x 8"d	\$2,502	58*
<b>Options</b>				
CAS	Casters, 2" dia Set of 4		\$327	2
ROTB	Rotating Base		\$535	8

Shipped by Truck\*

### To Order Specify

1. Quantity	<b>Finishes</b>	
2. Model	A PPP Color	MA Natural Maple
3. Side Panels: Wood Finish or PPP Color	CH Cherry	MM Mahogany
4. Back Panels: PPP Color	LC Light Cherry	LW Light Walnut
5. Options	HO Honey	W Walnut

See PPP Color Card or Web

### Specifications

- Back panels available in any PPP Color.
- Side panels available in Wood Finish or any PPP Color.
- 71/2'h clear acrylic front panels.
- Nominal Pocket ID: 121/4"w x 13'h x 11/4"d, on each side.
- Base: Black, 17"w x 13"d x 1"h. Includes adjustable foot glides.





# Freestanding Magazine & Literature Racks

Single Sided & Double Sided



5605/5606  
Base Depth 15"



DV5605

Model	Description	Size	List	Est. Ship Weight
5605	9 Pocket, Single Sided	30"w x 62"h x 2 1/2"d	\$1,697	48*
5606	18 Pocket, Double Sided	30"w x 62"h x 3 1/2"d	\$2,080	55*
<b>Options</b>				
DV5605	Pocket Divider, Clear Acrylic for Model 5605	6"h x 1 3/8" d	\$30	1
DV5606	Pocket Divider, Clear Acrylic for Model 5606	6"h x 1" d	\$30	1
CAS	Casters, 2" dia Set of 4		\$327	2

Shipped by Truck\*

### Frame Style

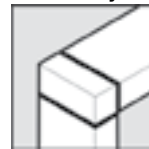

Linear

### To Order Specify

- Quantity
- Model
- Frame: Wood Finish
- Pocket Back Panel: PPP Color
- Base Panel: PPP Color
- Options

### Finishes

<b>A</b>	PPP Color	<b>MA</b>	Natural Maple
<b>CH</b>	Cherry	<b>MM</b>	Mahogany
<b>LC</b>	Light Cherry	<b>LW</b>	Light Walnut
<b>HO</b>	Honey	<b>W</b>	Walnut

See PPP Color Card or Web

### Specifications

- Pocket back panel available in any PPP Color.
- Bottom panel available in any PPP Color.
- Exterior back-side of single-sided Model 5605 finished in black.
- Front pocket panels: 7'h clear acrylic.
- Nominal pocket ID: Model 5605: 9"w x 12 1/4"h x 1 5/8"d.  
Model 5606: 9"w x 12 1/4"h x 1"d.
- Base: Black, 32"w x 15"d x 1'h. Includes adjustable foot glides.



# 487 Literature Racks & Universal Racks

With Acrylic Front Pockets, Holds Files, Brochures, Pamphlets, Envelopes, Etc.

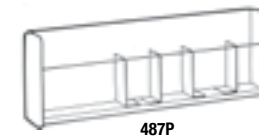

487P

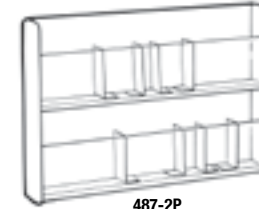

487-2P

Model	Description	Size	List	Est. Ship Weight
487P	1 Pocket	28"w x 12"h x 4"d	\$482	12
487-2P	2 Pocket High	28"w x 24"h x 4"d	\$810	25^
<b>Option</b>				
DV487	Magnetic Divider	6 1/2"h x 1 1/2"d	\$36	1

^UPS Dimensional Weight

### Edge Details



### To Order Specify

- Quantity
- Model
- Side Panels: Wood Finish or PPP Color
- Steel Back Panel and Dividers: PPP Color

### Finishes

<b>A</b>	PPP Color	<b>MM</b>	Mahogany
<b>CH</b>	Cherry	<b>LW</b>	Light Walnut
<b>LC</b>	Light Cherry	<b>W</b>	Walnut
<b>HO</b>	Honey		
<b>MA</b>	Natural Maple		

See PPP Color Card or Web

### Specifications

- All models feature 7'h clear acrylic lift-up front panels for easy cleaning.
- Nominal pocket ID: 3"d.
- Adjustable position magnetic dividers, 6 1/2"h x 1 1/2"d, included per pocket as follows:  
28"w models = 4 Dividers
- Screw mount.

© 11/2024

© 11/2024





# Newspaper, Mail Distribution, Magazine Racks, File & Chart Holders

Designed by Joe Sohn



13130

Model	Description	Size	Interior Dimensions	List	Est. Ship Weight
13130	1 Pocket w/ Lift-up Acrylic Front Panel	17"w x 12"h x 3"d	16"w x 11 1/2"h x 2"d	\$243	6

### To Order Specify

- Quantity
- Model
- Side Panel: Wood Finish
- Back Panel: PPP Color

Finishes			
A	PPP Color	MA	Natural Maple
CH	Cherry	MM	Mahogany
LC	Light Cherry	LW	Light Walnut
HO	Honey	W	Walnut

See PPP Color Card or Web

### Specifications

- Eyelet mount.

### Newspaper Racks *Designed by John Caldwell*

Model	Description	Size	Interior Dimensions	List	Est. Ship Weight
116	1 Pocket Wall Mounted, keyhole mount	15"w x 13 1/4"h x 3 1/2"d	15"w x 13"h x 1 3/4"d	\$272	6

### To Order Specify

- Quantity
- Model
- Pocket: PPP Color

Finish	
A	PPP Color

See PPP Color Card or Web



116



# Magazine Racks, File & Chart Holders

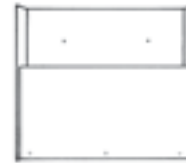

13115

Model	Description	Size	Interior Dimensions	List	Est. Ship Weight
<b>Steel Shell &amp; Front Panel</b>					
13115	1 Pocket	13 1/4"w x 11"h x 1 1/2"d	13"w x 10 1/2"h x 1 1/4"d	\$129	5
<b>Steel Shell &amp; Clear Acrylic Front Panel</b>					
13115P	1 Pocket	13 1/4"w x 11"h x 1 1/2"d	13"w x 10 1/2"h x 1 1/4"d	\$139	5

### To Order Specify

- Quantity
- Model
- Steel Components: PPP Color
- Rib: Wood Finish or PPP Color (on "P" Models)

Finishes			
A	PPP Color	MA	Natural Maple
CH	Cherry	MM	Mahogany
LC	Light Cherry	LW	Light Walnut
HO	Honey	W	Walnut

See PPP Color Card or Web

### Specifications

- 'P' models feature clear acrylic front panels.
- Screw mount.

### Acrylic *Designed by Tom Janicz*

Model	Description	Size	List	Est. Ship Weight
13139	1 Pocket	10"w x 13"h x 2"d	\$163	2

### To Order Specify

- Quantity
- Model

### Specifications

- Formed of one piece 1/8" clear hi-impact acrylic with polished edge.
- 'Spring front' holds magazines, literature, files or charts securely.
- Modular concept. Individual racks may be mounted vertically or horizontally, as needed.
- Screw mount.



13139

© 11/2024

© 11/2024





**PRICE LIST & SPECIFICATIONS**

Effective January 1, 2026

All Prices are Suggested List Price

Updated 11.03.25

**Section 1/1.1**

**DESIGNED FOR HIPAA**  
Medical File & Chart Holders  
Express Desk



13115H



13130H

©11/2024

©11/2024

**Medical File & Chart Holders**  
Designed for HIPAA

Model	Description	Size	Front Panel	List	Est. Ship Weight
13115H	1 Pocket, 10"w x 10"h Front Panel	13 ¼"w x 11"h x 1 ½"d	13"w x 10 ½"h x 1 ¼"d	\$164	5

**To Order Specify**

1. Quantity	<b>Finish</b> A PPP Color See PPP Color Card or Web
2. Model	
3. Finish	

**Specifications**

- Shell and Front Panel: Steel, available in any PPP Color.
- Screw mount.

*Designed by Joe Sohn*

Model	Description	Size	Front Panel	List	Est. Ship Weight
13130H	1 Pocket, 16"w x 10"h Front Panel	17"w x 12"h x 3"d	16"w x 11 ½"h x 2"d	\$289	8
13131H	1 Pocket - X-RAY Sized, 20 ¼"w x 12"h Front Panel	21"w x 16 ¾"h x 3"d	20 ¼"w x 15 ¾"h x 2"d	\$338	10

**To Order Specify**

1. Quantity	<b>Finishes</b> A PPP Color CH Cherry LC Light Cherry HO Honey MA Natural Maple MM Mahogany LW Light Walnut W Walnut See PPP Color Card or Web
2. Model	
3. Side Panel: Wood Finish	
4. Back Panel: PPP Color	
5. Front Panel: Wood Finish or PPP Color	

**Specifications**

- Front Panel: Wood finish or any PPP Color.
- Sides: Wood finish.
- Back Panel: Any PPP Color.
- Eyelet mount.



**Medical File & Chart Holders**  
Designed for HIPAA



4001H Holes

*Designed by Joe Ricchio*

Model	Description	Size	Front Panel	Textured PPP Color	Wood Veneer	Est. Ship Weight
4001H	1 Pocket HIPAA	12 3/4"w x 14"h x 2"d	12 1/2"w x 10"h	\$187	\$321	7^
4001HXL	1 Pocket HIPAA	12 3/4"w x 14"h x 4"d	12 1/2"w x 10"h	\$206	\$281	9^

**4001 Panel Styles**

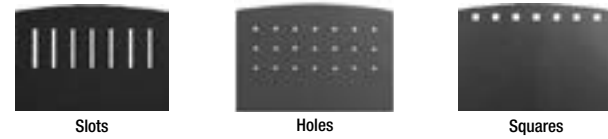

Slots

Holes

Squares



116

*Designed by John Caldwell*

Model	Description	Size	Interior Dimensions	List	Est. Ship Weight
116	1 Pocket Wall Mounted, keyhole mount	15"w x 13 1/4"h x 3 1/2"d	15"w x 13"h x 1 3/4"d	\$272	6

**To Order Specify**

- Quantity
- Model
- Finish

**Finish**

A PPP Color

See PPP Color Card or Web

**Specifications**

- Aluminum pocket available in any PPP Color.
- Keyhole mount.

© 11/2024

© 11/2024



**Medical File & Chart Holders**  
Designed for HIPAA

*Designed by Joe Ricchio*

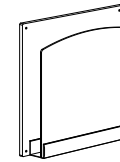

Model	Description	Size	Front Panel	Frosted Green	Quattro Platinum or Carbon	Est. Ship Weight
4101H	1 Pocket HIPAA	14"w x 14"h x 2 1/2"d	12 1/2"w x 10"h	\$187	\$267	6

**To Order Specify**

- Quantity
- Model
- Back Panel: Textured PPP Color
- Front Panel: Quattro Platinum, Carbon or Frosted Green

**Back Panel**

A PPP Color

**Front Panel**

Quattro Platinum  
Quattro Carbon  
Frosted Green

See PPP Color Card or Web

**Specifications**

- Front panel available in 3form®: Quattro Platinum, Quattro Carbon, or Plexiglas® Frosted Green Acrylic.
- Back panel in any Textured PPP Color.
- Shelf Trim: Natural Anodized Aluminum.
- Screw mount.

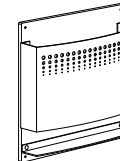

4111H Dots

Model	Description	Size	Front Panel	List	Est. Ship Weight
4111H	1 Pocket HIPAA	14"w x 14"h x 3"d	14"w x 10"h	\$238	7

**Pocket Styles**

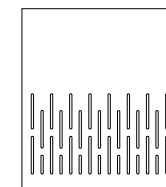

Slots

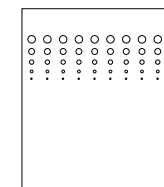

Dots

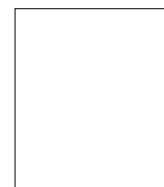

Plain

**To Order Specify**

- Quantity
- Model
- Back Panel: Textured PPP Color
- Front Panel Style: Slots, Dots, or Plain
- Front Panel: PPP Color

**Back Panel**

A PPP Color

**Front Panel**

A PPP Color

See PPP Color Card or Web

**Specifications**

- Curved steel front panel and shelf in any PPP Color.
- Back panel in any Textured PPP Color.
- Screw mount.



# Medical File & Chart Holders

Designed for HIPAA

Designed by Joe Ricchio



# 4800 Express Desk®

Fold-Down Wall Desks

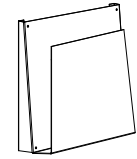

4141H

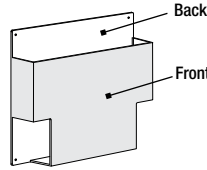

4151H

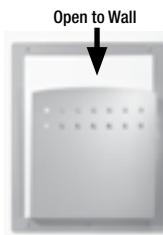

4006H Squares

Model	Description	Size	Front Panel	List	Est. Ship Weight
4141H	1 Pocket HIPAA	14"w x 14"h x 3 7/8"d	12 1/2"w x 10"h	\$171	5
4151H	1 Pocket HIPAA	15"w x 12 1/2"h x 2 1/2"d	15"w x 10"h	\$243	5
4006H	1 Pocket, Squares HIPAA	12 1/2"w x 15 1/2"h x 2"d	10"w x 10" h	\$209	6

To Order Specify		
1. Quantity	Finish (Model 4141H & 4006H) A PPP Color	Finish (Model 4151H) Front Stainless / Back White
2. Model		
3. Finish		
See PPP Color Card or Web		

### Specifications

- Screw mount (except Model 4141H which is Keyhole mount).
- Note: For multiple racks, each pocket mounts individually.

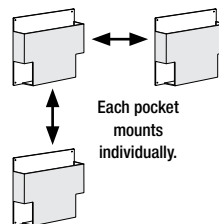

4800

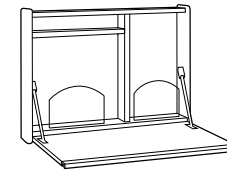

4808

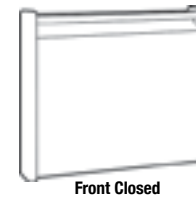

Front Closed

Model	Description	Size	Front Panel	List	Est. Ship Weight
4800	Soft White Laminate Interior, 20"w x 16"d Worksurface, 8 1/2"w x 7"h Acrylic Panel	22"w x 18"h x 4"d	19"w x 15"h x 2 3/4"d	\$808	25^
4800-D	Soft White Laminate Interior, 20"w x 16"d Worksurface, 8 1/2"w x 7"h Acrylic Panel, with Self-Closing Door	22"w x 18"h x 4"d	19"w x 15"h x 2 3/4"d	\$998	26^
4808	Soft White Laminate Interior, 28"w x 20"d Worksurface, 9"w x 19"h Tackable Fabric Panel, 18"w x 15"h Chart Pocket, Pen Shelf, (2x) 8 1/2"w x 7"h Acrylic Panels	30"w x 22"h x 4"d	27"w x 19"h x 2"d	\$1,310	35^
4808-D	Soft White Laminate Interior, 28"w x 20"d Worksurface, 9"w x 19"h Tackable Fabric Panel, 18"w x 15"h Chart Pocket, Pen Shelf, (2x) 8 1/2"w x 7"h Acrylic Panels, with Self-Closing Door	30"w x 22"h x 4"d	27"w x 19"h x 2"d	\$1,475	36^

^UPS Dimensional Weight

### Options

Chart 'Drop Slot' 16 3/4" w x 1 5/8"d (Available on model 4800)	\$112
Door Lock, Combination and Key	\$176
ColorCork. Washable, self-healing tackable panel with bacterial inhibitor, in place of tackable fabric For ColorCork specifications, see page 7.	\$170

Recessed Models, Custom Sizes and Laminates Available - Please submit your requirements for pricing.

### To Order Specify

1. Quantity	Side Panel Finishes A PPP Color CH Cherry LC Light Cherry HO Honey MA Natural Maple MM Mahogany W Walnut	Soft White: WA 1572-60 Cool Grey: WA D381-60 Maple: WA 7909-60	Fabric Selections - see page 7 Guilford of Maine Sprite Style 2671 Lido Style 2858 Crosstown Style 2526 COM: Customer's Own Material Page 7 for shipping information.
2. Model			
3. Side Panels: Wood Finish or PPP Color			
4. Door Front Laminate Color			
5. Interior Fabric Selection (if applicable)			
6. Options			
See PPP Color Card or Web			ColorCork Option 2186 2187 2209

### Specifications

- Side panels available in Wood Finish or any PPP Color.
- Work surface: Soft White laminate.
- Door includes magnetic catch, smooth-gliding adjustable stays and integral handle.
- Door front available in selected laminate colors.
- Handle finish same as side panels.
- 'D' Self-Closing Door Models: Door automatically retracts when weight is removed from work surface. Self-closing mechanism consists of pneumatic cylinders mounted on left, or both sides of the interior side panel. The pneumatic cylinder has been tested in excess of 15,000 cycles. Door load limit 30 lbs.
- Wall mounting cleat/bracket and hardware included.



© 11/2024

© 11/2024





# 4900 Express Desk®

## Fold-Down Wall Desks

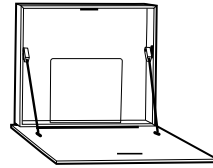

4900

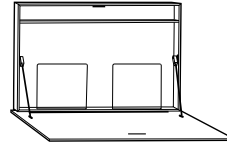

Front Closed

Model	Description	Size	Front Panel	List	Est. Ship Weight
4900	Soft White Laminate Interior, 20" w x 15" d Worksurface, 8 1/2" w x 8" h Acrylic Panel	20" w x 17 3/4" h x 3 3/4" d	19" w x 15" h x 2 3/4" d	\$803	19^
4900-D	Soft White Laminate Interior, 20" w x 15" d Worksurface, 8 1/2" w x 8" h Acrylic Panel, with Self-Closing Door	20" w x 17 3/4" h x 3 3/4" d	19" w x 15" h x 2 3/4" d	\$970	20^
4906	Soft White Laminate Interior, 30" w x 18" d Worksurface, Pen Shelf, and (2x) 8 1/2" w x 8" h Acrylic Panels	30" w x 20 3/4" h x 3 3/4" d	29" w x 18" h x 2 3/4" d	\$1,119	30^
4906-D	Soft White Laminate Interior, 30" w x 18" d Worksurface, Pen Shelf, and (2x) 8 1/2" w x 8" h Acrylic Panels, with Self-Closing Door	30" w x 20 3/4" h x 3 3/4" d	29" w x 18" h x 2 3/4" d	\$1,509	31^

^UPS Dimensional Weight

**Options**

Chart 'Drop Slot' 16 3/4" w x 1 5/8" d (Available on model 4800)	\$112
Door Lock, Combination and Key	\$176
Recessed Models, Custom Sizes and Laminates Available - Please submit your requirements for pricing.	

**To Order Specify**

- Quantity
- Model
- Door Front Laminate Color
- Options

**Door Front Laminate Color**

Soft White: WA 1572-60 -  
Cool Grey: WA D381-60 -  
Maple: WA 7909-60 -  
See Web

**Specifications**

- 5/8" thick wood frame. Finish: Soft White.
- Work surface: Soft White laminate.
- Door includes magnetic catch and smooth-gliding adjustable stays.
- Door front available in selected laminate colors.
- 'D' Self-Closing Door Models: Door automatically retracts when weight is removed from work surface. Self-closing mechanism consists of pneumatic cylinders mounted on left, or both sides of the interior side panel. The pneumatic cylinder has been tested in excess of 15,000 cycles. Door load limit 30 lbs.
- Back panel pre-drilled for screw attachment.



PETER PEPPER PRODUCTS  
EXPRESSIVE ESSENTIALS™

**PRICE LIST & SPECIFICATIONS**

Effective January 1, 2026

All Prices are Suggested List Price

Updated 11.03.25

**Section 1.3****healthFIRST®****Infection Prevention Centers**

Public & Exam - Wall Mounted & Countertop  
Side Loading - Wall Mounted

©11/2024

©11/2024



OSHPD Seismic Compliant  
Anchorage in California



ICX-1



ICX-2



ICX-2M



ICX-3



IC-S



IC-PH  
 Poster not included

Model	Description	Size	List	With Wood Trim CH, LC, HO, MA, MM, LW, W	Stainless Steel Upcharge	Est. Ship Weight
ICX-1	Dispenser holds disposable gowns, 1 mask box, 3 boxes of gloves/tissues	22 3/4" w 18"h x 4"d	\$632	\$728	\$126	17
ICX-1M	Dispenser holds disposable gowns, 1 mask box, 3 boxes of gloves/tissues, with literature rack	22 3/4" w 32"h x 4"d	N/A	\$1,045	\$126	22
ICX-2	Dispenser holds gowns, 1 mask box, 3 boxes of gloves/tissues with housing for sanitizer dispenser and drip dish	32"w x 18"h x 4"d	\$730	\$825	\$238	24
ICX-2M	Dispenser holds gowns, 1 mask box, 3 boxes of gloves/tissues with housing for sanitizer dispenser and drip dish, and literature rack	32"w x 32"h x 4"d	N/A	\$1,145	\$238	31
ICPX-3	Dispenser holds 3 boxes of gloves/tissues	11 3/8"w x 18"h x 4"d	\$315	\$411	\$146	8
IC-S	Sanitizer dispenser housing and drip dish. Dispenser and sanitizing product not included.	7"w x 18"h x 4"d	\$153	\$249	\$112	5
<b>Personal protection products not included.</b>						
<b>Options</b>						
IC-PV	Poster Holder, vertical, acrylic, wall-mounted.	8 1/2"w x 11"h x 3/8"d	\$60			2
IC-PH	Poster Holder, horizontal, acrylic, wall-mounted.	14"w x 11"h x 3/8"d	\$112			3
IC-L	Lock for dispenser		\$51			1
DV487	Magnetic Divider	6 1/2"h x 1 1/2"d	\$36		1	

**To Order Specify**

1. Quantity	<b>Wood Trim</b>	<b>Dispenser Front, Sanitizer Housing</b>	<b>Trash Receptacle</b>
2. Model	CH Cherry	Bright White	SS Stainless Steel
3. Wood Trim	LC Light Cherry	Soft White	A PPP Color
4. Dispenser Front, Sanitizer Housing Finish	HO Honey	Haze	<b>Magazine Pocket</b>
5. Magazine Pocket Finish	MA Natural Maple	Wheat	A PPP Color
6. Trash Receptacle Finish	MM Mahogany	Aluminum Metallic	
7. Options	LW Light Walnut	Taupe Metallic	
	W Walnut	SS Stainless Steel	

*See PPP Color Card or Web*

**Specifications**

- Wood Trim: 5/8" x 4", available in wood finish. Deduct 1/4" width on non-wood trim models.
- Dispenser Front: Steel with painted finish or Stainless Steel 304 - #4 finish. Interior finish: Soft White standard. Hinged at bottom.
- Interior Dispenser dimensions fits most standard products, not included.
- **Compartment Dimensions:**  
 Masks: (1) 7 1/2" w x 3 3/4" h x 3 3/4" d  
 Gloves/Tissues: 9 7/8" w x 16 1/4" h x 3 3/4" d  
 Gowns: 11 1/2" w x 12 3/4" h x 3 3/4" d
- Sanitizer Housing: Provides area for customer supplied sanitizer. Steel, same finish as Dispenser Front.
- Magazine Pocket: 14" h x 4" d. Steel, in any PPP Color. Front Retainer: Clear acrylic 7 1/2" h. Slides up for easy cleaning.
- Trash Receptacle: Steel, in any PPP Color or Stainless Steel 304 - #4 finish. Capacity 28 quarts, bag retainer included.
- Optional Poster Holders: Acrylic with mounted double-stick tape included. Top opening.
- Mounting hardware: 4 slotted holes with screws, included.
- Custom sizes available. Please submit your requirements.



ICP-1



ICP-2



ICP-2M



ICX-3



IC-S



IC-T

IC-TX

Model	Description	Size	List	With Wood Trim CH, LC, HO, MA, MM, LW, W	Stainless Steel Upcharge	Est. Ship Weight
ICP-1	Dispenser holds 2 mask boxes, 3 boxes of gloves/tissues	15 1/4" w x 18" h x 4" d	\$529	\$624	\$130	12
ICP-1M	Dispenser holds 2 mask boxes, 3 boxes of gloves/tissues, and includes a literature rack	15 1/4" w x 32" h x 4" d	N/A	\$879	\$130	17
ICP-2	Dispenser holds 2 mask boxes, 3 boxes of gloves/tissues with housing for sanitizer dispenser and drip dish	22 1/4" w x 18" h x 4" d	\$631	\$727	\$243	16
ICP-2M	Dispenser holds 2 mask boxes, 3 boxes of gloves/tissues with housing for sanitizer dispenser and drip dish, and literature rack	22 1/4" w x 32" h x 4" d	N/A	\$994	\$243	23
ICPX-3	Dispenser holds 3 boxes of gloves/tissues	11 3/8" w x 18" h x 4" d	\$315	\$411	\$146	8
IC-S	Sanitizer dispenser housing and drip dish. Dispenser and sanitizing product not included.	7" w x 18" h x 4" d	\$153	\$249	\$112	5
IC-T	Trash Receptacle, 28qt capacity, with hinged open top	14" w x 18" h x 7 3/4" d	\$408	N/A	\$476	15
IC-TX	Trash Receptacle, 28qt capacity with spring-loaded flap door	14" w x 18" h x 7 3/4" d	\$483	N/A	\$476	17

**To Order Specify**

1. Quantity	<b>Wood Trim</b>	<b>Dispenser Front, Sanitizer Housing</b>	<b>Trash Receptacle</b>
2. Model	CH Cherry	Bright White	SS Stainless Steel
3. Wood Trim	LC Light Cherry	Soft White	A PPP Color
4. Dispenser Front, Sanitizer Housing Finish	HO Honey	Haze	<b>Magazine Pocket</b>
5. Magazine Pocket Finish	MA Natural Maple	Wheat	A PPP Color
6. Trash Receptacle Finish	MM Mahogany	Aluminum Metallic	
7. Options	LW Light Walnut	Taupe Metallic	
	W Walnut	SS Stainless Steel	

*See PPP Color Card or Web*

**Specifications**

- Wood Trim: 5/8" x 4", available in wood finish. Deduct 1/4" width on non-wood trim models.
- Dispenser Front: Steel with painted finish or Stainless Steel 304 - #4 finish. Interior finish: Soft White standard. Hinged at bottom.
- Interior Dispenser dimensions fits most standard products, not included.
- **Compartment Dimensions:**  
 Masks: (2) 3 3/4" w x 8 1/4" h x 3 3/4" d  
 Gloves/Tissues: 9 7/8" w x 16 1/4" h x 3 3/4" d
- Sanitizer Housing: Provides area for customer supplied sanitizer. Steel, same finish as Dispenser Front.
- Magazine Pocket: 14" h x 4" d. Steel, in any PPP Color. Front Retainer: Clear acrylic 7 1/2" h. Slides up for easy cleaning.
- Trash Receptacle: Steel, in any PPP Color or Stainless Steel 304 - #4 finish. Capacity 28 quarts, bag retainer included.
- Optional Poster Holders: Acrylic with mounted double-stick tape included. Top opening.
- Mounting hardware: 4 slotted holes with screws, included.
- Custom sizes available. Please submit your requirements.





ICF-2



ICF-2M

Poster placement



ICF-2TX



ICF-2

Dispenser, open



ICF-P

Optional Poster Holder  
 Poster not included

Model	Description	Size	Wood Frame Finish CH, LC, HO, MA, MM, LW, W	Stainless Steel Upcharge	Est. Ship Weight
ICF-2	Dispenser holds 2 mask boxes, 3 boxes of gloves/tissues, with housing and drip dish for sanitizer dispenser	24 ½"w x 63"h x 15"d		\$243	82*
ICF-2M	Dispenser holds 2 mask boxes, 3 boxes of gloves/tissues, with housing and drip dish for sanitizer dispenser, and literature rack	24 ½"w x 63"h x 15"d		\$243	84*
ICF-2T	Dispenser holds 2 mask boxes, 3 boxes of gloves/tissues, with housing and drip dish for sanitizer dispenser, and a trash receptacle - open top	24 ½"w x 63"h x 15"d		\$719	94*
ICF-2TX	Dispenser holds 2 mask boxes, 3 boxes of gloves/tissues, with housing and drip dish for sanitizer dispenser, and a trash receptacle - with spring-loaded flap door	24 ½"w x 63"h x 15"d		\$719	96*
<b>Personal protection products not included.</b>					
<b>Options</b>					
ICF-P	Poster Holder, acrylic, mounts to top panel	21"w x 11"h x 3/8"d		\$198	3
IC-L	Lock for dispenser			\$51	1
DV487	Magnetic Divider	6 ½"h x 1 ½"d		\$36	1

Shipped by Truck\*

**To Order Specify**

1. Quantity	<b>Wood Frame Finish</b>	<b>Dispenser Front, Sanitizer Housing</b>	<b>Panel Finishes</b>
2. Model	CH Cherry	Bright White	A PPP Color
3. Wood Frame Finish	LC Light Cherry	Soft White	CH Cherry
4. Dispenser Front, Sanitizer Housing Finish	HO Honey	Haze	LC Light Cherry
5. Panel Finish	MA Natural Maple	Wheat	HO Honey
6. Magazine Pocket Finish (Model ICF-2M)	MM Mahogany	Aluminum Metallic	MA Natural Maple
7. Trash Receptacle Finish (Models ICF-2T & ICF-2TX)	LW Light Walnut	Taupe Metallic	MM Mahogany
8. Options	W Walnut	SS Stainless Steel	W Walnut
	<b>Trash Receptacle</b>		<b>Magazine Pocket</b>
	A PPP Color		A PPP Color
	SS Stainless Steel		

See PPP Color Card or Web

**Specifications**

- Wood Frame: 3/4" w x 5" d
- Compartments:
  - Masks: (2) 3¼" w x 8¼" h x 3¼" d
  - Gloves/Tissues: 9 7/8" w x 16¼" h x 3¼" d
  - Sanitizer: 7" w x 18" h x 3¼" d
  - Trash (ICF-2T & -2TX Models): 14" w x 18" h x 7¼" d
  - Capacity: 28 quarts, bag retainer included
- Dispenser Front: Steel with painted finish or Stainless Steel 304 - #4 finish. Interior finish: Soft White standard. Hinged at bottom.
- Interior dispenser dimensions fits most standard products, not included.
- Sanitizer Housing: Provides area for customer supplied sanitizer. Steel, same finish as Dispenser Front.
- Magazine Pocket: (ICF-2M Model) 14" h x 4" d. Steel, in any PPP Color. Front Retainer: Clear acrylic 7½" h. Slides up for easy cleaning.
- Panels: Melamine wood finish or any PPP Color.
- Trash Receptacle: Steel, in any PPP Color or Stainless Steel 304 - #4 finish.
- Optional Poster Holder: Acrylic, pre-mounted with double stick tape to top panel. Top opening.
- Base: Melamine, graphite finish with adjustable foot glides.
- Custom sizes available. Please submit your requirements.

**PRICE LIST & SPECIFICATIONS**

Effective January 1, 2026

All Prices are Suggested List Price

Updated 11.03.25

© 11/2024

© 11/2024



# ICON Healthcare Alert Signage

## Corridor Alert Signs



C8 shown with Rectilinear Header and EMB



C10



C12

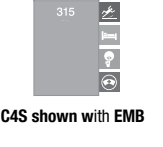

C4S shown with EMB

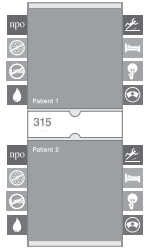

DP16 shown with EMB

The ICON Corridor Alert sign communicates critical patient information to the doctor, nurse or clinician. Easily lock and unlock the colorful information tabs as needed, using the “push and slide” system concealed behind the hinged panel. Icon tabs are 1 7/8”w x 1 7/8”h. Combine additional Infectious Disease Control inserts and room identification in a single system. ICON is ADA compliant and may be customized to meet the requirements of your facility, department or unit. Please submit your requirements.

Model	Description	Size	No Header*	With Header*	Dry Erase Film Upcharge	Est. Ship Weight
<b>8 1/2” wide</b>						
C8	8 Icon Tabs, bottom hinge	8 1/2”w x 12”h	\$540	\$620	\$89	3
C10	10 Icon Tabs, bottom hinge	8 1/2”w x 15”h	\$638	\$717	\$110	4
C12	12 Icon Tabs, bottom hinge	8 1/2”w x 16 1/2”h	\$690	\$770	\$118	5

For Icon Tabs, *see page 48*.  
\*Height dimensions include headers. Deduct 2 1/2” for no header models.

**Header Styles - C8, C10 & C12 models only (shown with optional EMB)**

  
No Header

  
Rectilinear

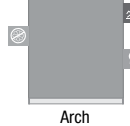
  
Arch

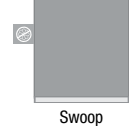
  
Swoop

Model	Description	Size	No Header*	Dry Erase Film Upcharge	Est. Ship Weight
<b>Single-Sided, 6 1/2”w</b>					
C4S	4 Icon Tabs, single-sided, top hinge	6 1/2”w x 9 3/4”h	\$413	\$69	2

For Icon Tabs, *see page 48*.

Model	Description	Size	With Header*	Dry Erase Film Upcharge	Est. Ship Weight
<b>Dual Occupancy Sign</b>					
DP16	8 Icon Tabs Per Patient - Individual Patient 1 & 2 ID. Top panel hinged at top, bottom panel hinged at bottom.	8 1/2”w x 22”h	\$1,225	\$187	6

For Icon Tabs, *see page 48*. FOB Pennsylvania

**Specifications & Ordering Information** (See pages 49-50)



# ICON Healthcare Alert Signage

## Corridor Alert Signs



PSTR  
Staff Education Poster



C8 with CPH  
Horizontal placard slides into the front hinged panel frame



C12 with CPD  
Vertical placard slides into the front hinged panel frame



C8 with CPU  
Placard holder mounts under the hinged panel and the vertical placard slides into place

Model	Description	Size	List	Est. Ship Weight
<b>Options</b>				
EMB	Embossed Room Number, Helvetica 3/4”h and Braille on header or hinged panel, ADAAG compliant		\$154	
ICON	Replacement Icon Tabs		\$73	
PSTR	Staff Education Poster, customized with your specific icons. Clear acrylic holder.	22”w x 28”h	\$374	8
	Text instead of Icon image - one-time set up, each		\$131	
	Custom Icon design - one-time set up, each		\$622	
	Logos and customs images		\$84	
	Any PMS Icon or hinged panel color		n/c	
<b>Infectious Disease Control Placard Inserts</b>				
The Infectious Disease Control Placard Inserts along with “Do Not Enter” help to ensure better outcomes for your National Patient Safety goal program for reducing the incidence of healthcare associated infections (HAI’s). These inserts are digitally printed on durable, tear and moisture resistant material. Placards insert into a non-glare acrylic holder. Additional inserts can be customized to your needs. Please submit your requirements.				
CPH	Horizontal Placard Insert for hinged panel (Models C8, C10, C12 & DP16)	8 3/8”w x 3 7/8”h	\$209	1
	Set of 4, double-sided, with acrylic holder			
CPH-A	Acrylic holder only, no placards	8 3/8”w x 3 7/8”h	\$80	
CPD	Vertical Placard Insert for hinged panel (Models C10 & C12)	8 3/8”w x 10 3/4”h	\$383	1
	Set of 4, double-sided, with acrylic holder			
CPD-A	Acrylic holder only, no placards	8 3/8”w x 10 3/4”h	\$154	1
CPU	Vertical Placard Insert - mounts under hinged panel (Models C8, C10, C12 & DP16)	8 3/8”w x 10 3/4”h	\$383	1
	Set of 4, double-sided, with acrylic holder			
CPU-A	Acrylic holder only, no placards	8 3/8”w x 10 3/4”h	\$154	

FOB Pennsylvania

**CPH — Set of 4 double-sided placards**

Front



Back





Front





Back











**CPD & CPU**

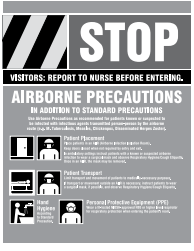

**Specifications & Ordering Information** (See pages 49-50)



# ICON Healthcare Alert Signage

## Information Icon Library

The standardized Information Icon library is easily augmented with any custom symbols and icons your care providers desire. Here is a sample of symbols currently found in the ICON library. We can design custom symbols to meet your facility's needs and brand. All icons can be designed to be multi-lingual.

### Icon Colors - Specify icon number and color.\*

PMS referenced colors approximate actual colors.  
Contact factory for samples.

Red/PMS 200M		Ocean Mist PMS 5425M
Orange PMS 021M		Naval Blue PMS 286M
Yellow PMS 1235M		Purple PMS 2607M
Green PMS 349M		

\*Text, custom colors and icons available. Please submit your requirements.



### Icon Index

1. Fall Risk
2. Nothing By Mouth
3. Immuno Compromise
4. Droplet Isolation
5. Not Allowed to Ambulate
6. Contact Isolation
7. Deceased
8. Pain Assessment
9. Patient at Test
10. Dizziness
11. Elopement
12. Latex Allergies
13. Physician Consult
14. Patient Code
15. Patient Code
16. Patient Code
17. Patient Code
18. Special Precautions
19. See Nurse
20. See Nurse Before Entering
21. Special Communications Needs
22. Seizure Precautions
23. Mother with Child
24. Calorie Count
25. I & O
26. Strict I & O
27. Hearing Impaired
28. Sight Impaired
29. No Venipuncture in Right Arm
30. No Venipuncture in Left Arm
31. Daily Weights
32. Fluid Restrictions
33. Swallowing Precautions
34. Quiet Please!
35. Caution Oxygen
36. Special Output Sampling
37. Neutropenic Precautions
38. Transplant Precautions
39. Transfusion Protocol
40. Allergy Precautions
41. Please Keep Door Closed
42. Wash Hands Before Entering
43. 24 Hour Specimen
44. Children Present
45. Plant Allergy Precaution
46. Food Allergy Precaution
47. Patient With Family
48. Patient With Pastor
49. Patient Eating
50. Aphasic
51. Aspiration Precautions
52. Bereavement
53. Pre-Term Infant
54. Do Not Resuscitate
55. Chair Alarm
56. Physician
57. Bloodwork
58. Consent
59. Injection
60. MRSA Infection
61. Labs Pending
62. Patient Demise
63. Biohazard
64. Chemotherapy
65. Aggression
66. Nurse to Remove Tray
67. Epidural
68. No Bottle
69. Shh, Quiet
70. Asphasia

# ICON Healthcare Alert Signage

## Ordering Information and Specifications

**HOW TO SPECIFY ICON TABS**

Left: top to bottom & Right: top to bottom  
Icon number (see page 48) and color

#2 purple	#1 naval blue
#3 red	#5 ocean mist
#12 orange	#34 yellow
#4 green	#20 red

**Header Styles - C8, C10 and C12 Models only**  
Shown with optional EMB - Embossed Room Number and Braille

**Tab Configurations - C8, C10, C12 & DP Models**

**Tab Configurations - Model C4S**

© 11/2024

© 11/2024



**CLOCKS**

Calendar Clocks

Time-Zone Clocks

Electronic Digital Clocks

To Order Specify		
<ol style="list-style-type: none"> <li>1. Quantity</li> <li>2. Model</li> <li>3. Panel Color</li> <li>4. Header Style (C8, C10 &amp; C12 Models only)</li> <li>5. Header Color</li> <li>6. Icon Tab Number, Tab Color and Order (left top to bottom and right top to bottom)</li> <li>7. Options</li> </ol>	<p><b>Header Styles</b> (C8, C10 &amp; C12 Models only)</p> <p>No Header                      Rectilinear                      Arch                      Swoop</p> <p><b>Header &amp; Panel Finishes</b></p> <p>Soft White                      Haze                      Seasand                      Wheat                      Khaki                      Lemongrass                      Ocean Mist                      Aluminum Metallic                      Taupe Metallic</p> <p style="text-align: right;"><i>See PPP Color Card or Web</i></p>	<p><b>Icon Tab Colors</b></p> <p>Red                      Orange                      Yellow                      Green                      Ocean Mist                      Naval Blue                      Purple</p> <p>Custom Colors                      (Submit your requirements)</p> <p><b>Icon Tab Numbers: See page 48</b></p>

**Specifications**

The ICON Healthcare Alert signs communicate critical patient information to the next doctor, nurse or clinician. Easily lock and unlock the colorful information tabs as needed, using the “push and slide” system concealed behind the hinged panel. Combine room identification and additional Infectious Disease Control inserts in a single system.

ICON is ADA (Accessibility Guidelines) compliant and may be customized to meet the requirements of your facility, department or unit.

- Construction: 24 ga. galvaneal steel hinged panel with magnetic latch. ½” depth. Hinged panel is magnetic and finished in acrylic polyurethane. Backer .063 aluminum.
- Header (C8, C10, C12 & DP Models only): Acrylic 2½”h x ¾”d. Dimensions on C8, C10 & C12 models include headers - subtract 2½” for models without headers.
- **Optional Embossed Room Number/Letter.** Helvetica type ¾”h, and Braille. Submit list of room numbers and specify placement on header and/or hinged panel when applicable.
- Icon Tabs: White icon on color tab, *specify color*. Digitally printed on durable .125” expanded PVC. Icon tabs are easily removed or changed.  
 C & DP Models: 1 7/8”w x 1 7/8”h.
- Placard Inserts: With non-glare acrylic lens.
- Optional dry erase writing surface film for hinged panel — Upcharge.
- Mounting: Double-sided tape, standard; concealed pre-drilled holes for screw fasteners on request.
- Included: All models include an Icon Index decal, mounted to the inside of the hinged panel for easy reference.

**PRICE LIST & SPECIFICATIONS**

Effective January 1, 2026

All Prices are Suggested List Price

Updated 11.03.25

© 11/2024

© 11/2024





343  
Aluminum Finish Bezel

343 Clock - 11¾" Diameter			
Model	Description	Size	Est. Ship Weight
343	Aluminum finish bezel	11 ¾" dia x 1 ½"d	4

**To Order Specify**

- Quantity
- Model

**Specifications**

- Available ONLY as listed.
- Glass cover. Face color is white.
- Quartz Battery Movement.



300 & 300P

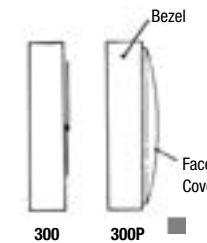

300

300P



382

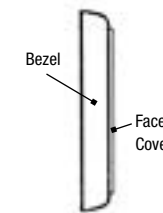

Bezel

Face Cover

300 Clocks - 10" Diameter		Finishes		Est. Ship Weight	
Model	Description	A	H		
300	Without Acrylic Cover	10" dia x 1 ¾"d	\$271	\$429	3
300P	With Acrylic Cover	10" dia x 2 ¾"d	\$337	\$501	4
380 Clocks - 12" & 16" Diameter					
382	With Acrylic Cover	12" dia x 2"d	\$408	\$601	5
386	With Acrylic Cover	16" dia x 2"d	\$568	\$811	6

**Options**

ALPC	Anti-Ligature Clock Cover for Models 300, 300P & 382 ONLY	\$182
------	---	-------

Available with SyncTech® Wireless Time, see Section 2.1, page 57.

**To Order Specify**

- Quantity
  - Model
  - Bezel Finish
  - Clock Face Number
  - Options
- Select Face Number from 'Clock Face Selector'. See page 56.

- Bezel Finishes**
- A** PPP Color  
**H** Polished Chrome

See PPP Color Card or Web

**Specifications**

- Bezel available in any PPP Color or Polished Chrome.
- Quartz Battery Movement.
- Red sweep second hand included.





501

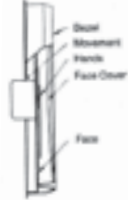

501 Clock			Est. Ship Weight	
Model	Description	Size	List	
501	Quartz	14" dia x 2"d	\$482	6
<b>Options</b>			\$297	
12 Hour Electric Movement per Face. Note: Model 501 electric requires recessed 4" x 4" x 2" junction box				

syncTECH® Available with SyncTech® Wireless Time, see Section 2.1, page 57.

To Order Specify	
1. Quantity 2. Model 3. Bezel Finish 4. Clock Face Number 5. <b>Option:</b> Movement	<b>Bezel Finishes</b> A PPP Color
Select Face Number from 'Clock Face Selector'. See page 62. See PPP Color Card or Web	

- Specifications**
- Bezel & Housing available in any PPP Color.
  - Quartz Battery Movement.
  - Acrylic cover and red sweep second hand included.

843 Clocks - 14" Diameter		Finishes		Est. Ship Weight
Model	Description	A	H	
843	Without Acrylic Cover	\$348	\$550	5
843P	With Acrylic Cover	\$453	\$665	6
845 Clocks - 14" Diameter				
845	With Acrylic Cover	\$490	\$699	6

Options		
24 Hour Special Quartz Movement. Clock Face # 10 only		\$79

syncTECH® Available with SyncTech® Wireless Time, see Section 2.1, page 57.

To Order Specify	
1. Quantity 2. Model 3. Bezel Finish 4. Clock Face Number 5. <b>Option:</b> 24 Hour Quartz Movement. Specify Clock Face #10	<b>Bezel Finishes</b> A PPP Color H Polished Chrome
Select Face Number from 'Clock Face Selector'. See page 56. See PPP Color Card or Web	

- Specifications**
- Bezel available in any PPP Color or Polished Chrome.
  - Quartz Battery Movement.
  - Red sweep second hand included.

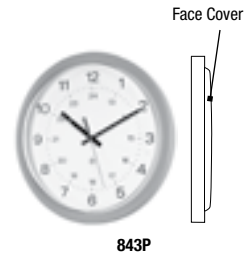

843P



845

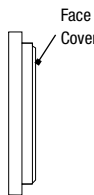

Design by Joe Ricchio and Eric MacDonald



820 Clock  
Shown with Face Number 36



835 Clock

820 Clock			Est. Ship Weight	
Model	Description	Size	List	
820	With flush Acrylic Cover	13 7/8" dia x 1 5/8"d	\$348	5

syncTECH® Available with SyncTech® Wireless Time, see Section 2.1, page 57.

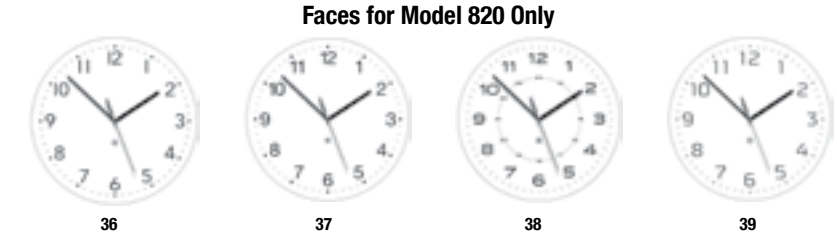

To Order Specify	
1. Quantity 2. Model 3. Bezel Finish 4. Clock Face Number (select face number)	<b>Bezel Finish</b> A PPP Color See PPP Color Card or Web

- Specifications**
- Bezel available in any PPP Color.
  - Quartz battery movement.
  - Red sweep second hand included.

835 Clock			Est. Ship Weight	
Model	Description	Size	List	
835	Clear acrylic Clock with black surface graphics	14" dia x 1"d	\$206	3

To Order Specify	
1. Quantity 2. Model	

- Specifications**
- Surface graphics on 1/8" clear acrylic face.
  - Quartz battery movement.
  - Red sweep second hand included.

© 11/2024

© 11/2024



**Electronic Digital Clocks  
Calendar Clocks  
Time-Zone Clocks**



Z1820



Z1862

Model	Description	Size	List	Est. Ship Weight
<b>Standard 4 Digit, Hours &amp; Minutes</b>				
Z1810	2" Segmented LED	12"w x 6"h x 2"d	\$966	5
Z1820	4" Segmented LED	15"w x 8"h x 2"d	\$1,493	7
<b>4 Time-Zone, Hours &amp; Minutes</b>				
Z1853	2" Segmented LED	48"w x 6"h x 2"d	\$5,505	14^
<b>8 Time-Zone, Hours &amp; Minutes</b>				
Z1849	2" Segmented LED	84"w x 6"h x 2"d	\$11,115	15^
<b>Options Hours, Minutes, Month &amp; Date</b>				
Z1862	2" Segmented LED, All numeric readout	10"w x 10"h x 2"d	\$2,343	6

^UPS Dimensional Weight



Z1853

**To Order Specify**

<ol style="list-style-type: none"> <li>Quantity</li> <li>Model</li> <li>Frame Finish</li> <li>12 or 24 Hour</li> <li>'Home' Zone Name (Local Zone)</li> <li>Time-Zone Names, left to right (Models Z1853 &amp; Z1849)</li> <li><b>Options:</b> See page 57.</li> </ol>	<b>Finish</b> <b>GR</b> Graphite Anodized Aluminum  See Web
--	--

**Specifications**

- Automatic Daylight Savings Time adjustment on all models.
- Accuracy: +/- 2 seconds per year.

**Super-Bright Red LEDs Specifications**

- Standard and Time-Zone Clocks: 24 hour mode is user selectable. 12 hour model includes LED 'PM' indicator. Atomic Time for superior accuracy. Automatic standard/daylight savings time correction supporting all American and International Time-Zones, using a 100 year calendar and current Daylight Savings Time rules in effect at time of order.
- Up to 10 year lithium rechargeable battery (standard) provides backup power reserve to time chip in case of power interruption. When power is resumed, the clock will display the correct time.

**Time-Zone Clocks ONLY:**

- Specify the local 'Home' zone and time-zone names, reading left-to-right. All other zones will set automatically.
- Infrared remote control included.

**Power Requirements**

- 120V AC, 60Hz internal transformer. UL listed.

**Electronic Digital Clocks  
Calendar Clocks  
Time-Zone Clocks**

<b>Remote Control</b>		
Infrared Remote Control Unit for Models Z1810, Z1820, Z1862. Remote control not included.	\$375	
Remote control. One remote may control multiple clocks.	\$289	1
Remote control is included with models Z1853 & Z1862.		

**Please Submit your Requirements for other Features and Functions**

- Elapsed-Time Clocks: Count up or down
- Wood, Color or Metal Finishes
- Computer & Wireless Remote Control Panels
- Logo silk-screening on clock lens
- Custom Configurations
- Special Time-Zones: From 2-24 Zones
- 60 Character Message Displays
- Other Formats: Metric, Julian or Double-Face
- Other Voltage: 220v
- Visual Alert System (Fire Bell) audible alarm

© 11/2024

© 11/2024



**PRICE LIST & SPECIFICATIONS**

Effective January 1, 2026

All Prices are Suggested List Price

Updated 11.03.25



2



5



7



8



13



14



24

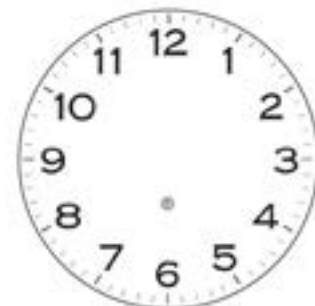

32



35

FACES 36-39  
FOR MODELS 820 ONLY



36



37



38



39

©11/2024

©11/2024



OSHPD Seismic Compliant  
Anchorage in California



Combine wireless simplicity with synchronization as clocks receive time information over Wi-Fi from an internet or in-house NTP Server. Simply power the clocks, connect to your network, and go. PPP Wi-Fi Clocks connect to a wireless local network and are capable of taking the accurate time from any NTP server, so a master clock is only needed where the facilities Wi-Fi signal does not cover the entire area requiring clock installations. The Wi-Fi receiver clocks can be pre-programmed with the addresses of public internet or in-house NTP servers.

Description	List	Est. Ship Weight
SyncTech Electric Movement Upcharge, 120V AC, 60Hz	\$204	1

To Order Specify
<ol style="list-style-type: none"> <li>Quantity</li> <li>Model</li> <li>Options</li> </ol>

Customer's own Wi-Fi network and internet service are required and not included with the SyncTech® Synchronized Time System.



The 2.4 GHz Wireless Synchronized Time System provides a multi-path mesh network for clock-to-clock transmission of synchronized time. The time signal is then broadcast to all clocks once per second. Each battery-operated clock transmits up to 150 feet in all directions, repeating the synchronized time signal clock-to-clock, throughout an entire facility.

2.4 GHz master clocks obtain accurate U.S. time from two sources: Network Time Protocol and GPS.



Model	Description	Size	List	Est. Ship Weight
<b>Network Time Protocol Master Clock</b> Obtains time from local or internet time servers via the on-board Ethernet interface card***				
WCMNT5-2.4	Network Time Protocol Master Clock. 2.4 GHz Transmitter	9 1/2" w x 2 1/2" h x 5 1/2" d	\$4,267	4
<b>GPS Master Clock</b> Obtains time from Global Positioning Satellites via the rooftop antenna and 100 foot cable (included)				
WCMGP5-2.4	GPS Master Clock. 2.4 GHz Transmitter	9 1/2" w x 2 1/2" h x 5 1/2" d	\$5,118	4
<b>Wall Repeater</b> Repeaters are used to provide continuous network coverage where clock placement is greater than every 150 feet. The repeater simply plugs into a wall outlet and begins repeating time updates. No configuration is required.				
WR2.4	2.4 GHz Wall Repeater	2 1/4" w x 4 1/2" h x 1 1/2" d	\$636	2
WR2.4C	Drop ceiling tile with built-in 2.4 GHz Repeater. Contact factory for details.	12" w x 24" d	\$1,603	12
<b>Movements</b> SyncTech Electric Movement Upcharge, 120V AC, 60Hz				
			\$204	1

To Order Specify
<ol style="list-style-type: none"> <li>Quantity</li> <li>Model</li> <li>Options</li> </ol>

**Master Clock Specifications**  
2.4 GHz Transmitter included on all master clocks. No FCC License required.

Our standard 2.4 GHz transmitter is sufficient for most single commercial building construction.

Each battery-operated clock transmits up to 150 feet in all directions, repeating the synchronized time signal clock-to-clock, throughout an entire facility. All clocks receive and re-broadcast time updates once per second, creating a Multi-path mesh network. However, depending on construction, layout and features, repeaters may be required.

Automatic Daylight Savings Time adjustments. A Mini Master is included with every master clock. It can be used to confirm signal coverage, as an accurate time source for installing analog clocks or as a temporary repeater.

Site plan/surveys are available to help determine your exact needs. Contact the factory.

Ethernet connector supplied for NTP time acquisition. Simultaneous GPS acquisition permitted with Wireless GPS receiver.

Accurate to a fraction of a second over 10 years.  
Operating temperature: 32°F - 120°F  
Humidity: 0-95% non-condensing

**Time Zones**  
Multiple LED time zone models available. Contact Factory.

**Alarms**  
Using a wireless relay the 2.4 GHz System can be used to activate mechanical bells or horns. Can activate any combination of 12 alarm zones.

**Power Requirements**  
110V AC.  
UL listed wall 'plug-in' type. 10-year lithium battery back up.

\*\* Internet service is required and not included with the PPP Wireless Synchronized Time System.

© 11/2024

© 11/2024



Model	Description	Size	List	Est. Ship Weight
<b>Digital Clock</b>				
WC2000	2" h Red hours and minutes, 1.8" h seconds Segmented 4 digit Red LED Display	12 ¼" w x 6 ¼" h x 2 ¼" d	\$1,357	5
WC2001	Segmented 6 digit Red LED Display  Although the signal is wireless, the LED's require 120V AC, 60Hz power to illuminate this clock. Other: 4" digit height, Green and Blue colors available at upcharge. Please submit your requirements	18 ¼" w x 6 ¼" h x 2 ¼" d	\$1,876	7
WC300	Digital LCD Calendar Wall Clock, 2.4 GHz Wireless. Hour, minute and second display.  Calendar displays day of week and temperature. Battery powered, 3 year battery pack.  2.4 GHz system only	17" w x 10 ½" h x 1 ½" d	\$951	3
<b>To Order Specify</b>				
<ol style="list-style-type: none"> <li>Quantity</li> <li>Model</li> <li>Receiver: Wi-Fi or 2.4 GHz</li> <li>Frame Finish (Models WC2000 - WC2001)</li> </ol>		<b>Frame Finish</b> Brushed Aluminum Black Aluminum		
<b>WC100 &amp; 105 Analog Clocks</b>				
Model	Description	Size	List	Est. Ship Weight
WC100	Brushed Aluminum bezel & face graphics	11 ¾" dia x 2" d	\$789	5
WC105	Black Plastic bezel & face graphics	11 ¾" dia x 2" d	\$645	5
<b>To Order Specify</b>				
<ol style="list-style-type: none"> <li>Quantity</li> <li>Model</li> <li>Receiver: Wi-Fi or 2.4 GHz</li> </ol>				
<b>Specifications</b>				
<ul style="list-style-type: none"> <li>Models available only as listed.</li> <li>Cover: Glass, non-tempered.</li> <li>Red second hand included on all Analog Receiver Clocks.</li> <li>Standard 10 year lithium battery pack. 3 year battery pack on Model WC300 only.</li> </ul> For optional electric movement, <i>See pages 58-59.</i>				



300P, 382, 386 & 843P Analog Clocks			Finishes		Est. Ship Weight
Model	Description	Size	A	H	
300P*	With Acrylic Cover	10" dia x 2 ¾" d	\$985	\$1,210	4
382*	With Acrylic Cover	12" dia x 2" d	\$1,056	\$1,310	5
386*	With Acrylic Cover	16" dia x 2" d	\$1,216	\$1,519	6
843P*	With Acrylic Cover	14" dia x 2" d	\$1,101	\$1,373	6
<b>To Order Specify</b>					
<ol style="list-style-type: none"> <li>Quantity</li> <li>Model</li> <li>Receiver: Wi-Fi or 2.4 GHz</li> <li>Bezel Finish</li> <li>Clock Face Number</li> </ol> Select Face Number from 'Clock Face Selector'. See page 64.				<b>Finishes</b> A PPP Color H Polished Chrome  <i>See PPP Color Card</i>	
<b>Specifications</b>					
<ul style="list-style-type: none"> <li>Bezel available in any PPP Color or Polished Chrome.</li> <li>Red second hand included on all Analog Receiver Clocks.</li> <li>Standard 10 year lithium battery pack.</li> </ul> For optional electric movement, <i>See pages 58-59.</i>					



© 11/2024

© 11/2024

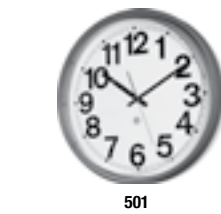

501

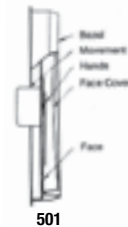

501



820 Clock

Shown with Face Number 36

Model	Description	Size	List	Est. Ship Weight
501*	With Acrylic Cover	14" dia x 2"d	\$1,130	6

To Order Specify	
<ol style="list-style-type: none"> <li>Quantity</li> <li>Model</li> <li>Receiver: Wi-Fi or 2.4 GHz</li> <li>Bezel Finish</li> <li>Housing Finish</li> <li>Clock Face Number</li> </ol> <p>Select Face Number from 'Clock Face Selector'. See page 64.</p>	<p><b>Bezel Finishes</b></p> <p><b>A</b> PPP Color</p> <p>See PPP Color Card or Web</p>

820 Clock		Size	List	Est. Ship Weight
Model	Description	13 7/8" dia x 1 5/8"d	\$997	5

**Faces for Model 820 Only**



To Order Specify	
<ol style="list-style-type: none"> <li>Quantity</li> <li>Model</li> <li>Bezel Finish</li> <li>Clock Face Number (select face number)</li> </ol>	<p><b>Bezel Finish</b></p> <p><b>A</b> PPP Color</p> <p>See PPP Color Card or Web</p>

- Specifications**
- Bezel available in any PPP Color. ....
  - Quartz battery movement.
  - Red sweep second hand included.
  - Standard 10 year lithium battery pack. For optional electric movement, See pages 58-59.

845 Analog Clock <i>Designed by Joe Sohn</i>		Finishes		Est. Ship Weight
Model	Description	A	H	
845*	With Acrylic Cover	\$1,137	\$1,425	6

To Order Specify	
<ol style="list-style-type: none"> <li>Quantity</li> <li>Model</li> <li>Receiver: Wi-Fi or 2.4 GHz</li> <li>Bezel Finish</li> <li>Clock Face Number</li> </ol> <p>Select Face Number from 'Clock Face Selector'. See page 64.</p>	<p><b>Bezel Finishes</b></p> <p><b>A</b> PPP Color</p> <p><b>H</b> Polished Chrome</p> <p>See PPP Color Card or Web</p>

- Specifications**
- Bezel available in any PPP Color or Polished Chrome.
  - Red second hand included on all Analog Receiver Clocks.
  - Standard 10 year lithium battery pack. For optional electric movement, See pages 58-59.

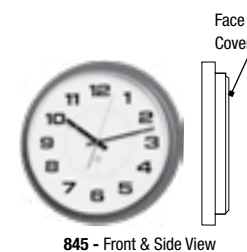

845 - Front & Side View

	SyncTech® Wi-Fi	SyncTech® 2.4 GHz
<b>Master Clock</b>	None.  Clocks independently receive accurate time from an NTP server via a facility's own Wi-Fi network.	2.4 GHz transmitter included on all master clocks.  A Mini Master is included with every master clock. It can be used to confirm signal coverage, as an accurate time source for installing analog clocks or as a temporary repeater.
<b>Time Sources</b>	NTP	NTP GPS  NTP + GPS receivers can be used in single or simultaneous configurations.
<b>Accuracy</b>	Accurate to a fraction of a second over 10 years.	Accurate to a fraction of a second over 10 years.
<b>Operating Temperature</b>	32°F - 120°F.	32°F - 120°F.
<b>Operating Humidity</b>	0 - 95% non-condensing.	0 - 95% non-condensing.
<b>FCC License Requirements</b>	No license required.	No license required.
<b>Power Requirements (Master Clocks)</b>	-	110V AC, internal transformer (included). UL listed wall 'plug-in' type. 10-year lithium battery back up.
<b>Time Zones</b>	-	-
<b>Alarms</b>	-	Mechanical bells or horns. Activate any combination of 12 alarm zones.
<b>Typical Installation</b>	• Single or multi-building campuses with wireless infrastructure.	• Single building construction with receiver clocks placed within 150' radius of one another.
<b>Site Survey</b>	A site plan/survey is available to help determine your exact needs. Contact the factory.	

**SYNCHRONIZED TIME EVERYWHERE**

**CORPORATE**

Eliminate HR time related conflicts including employee tardiness, missed meetings, or presentations off schedule. Scheduling problems due to an inaccurate time system can impact the entire facility and company. Synchronizing clocks between multiple buildings is easy and cost effective.

**HEALTHCARE**

Within healthcare organizations, accurate, synchronized time is critical. The legal consequences of inaccurate time can be devastating to any facility. syncTECH® eliminates potential liabilities from inaccurate, independently set clocks when documenting the exact time for vital statistics, procedures and medical timelines. Transmitter operates on a business frequency, a time tested method of transmitting information, without interference with sensitive medical equipment.

**EDUCATION**

Wirelessly synchronize clocks between multiple buildings and across the entire campus. Inaccurate clocks can have a negative impact on the overall image of the university. Students may be late for class due to the inaccurate university time displays. This problem is compounded when time displays differ between buildings on campus.



© 11/2024

© 11/2024



**PRICE LIST & SPECIFICATIONS**

Effective January 1, 2026

All Prices are Suggested List Price

Updated 11.03.25



2



5



7



8



13



14



24



32



35

FACES 36-39  
FOR MODELS 820 ONLY

©11/2024

©11/2024



36



37



38



39

**15% Surcharge  
On This Category  
Until Further Notice**  
*Please apply to product in  
this pricelist when quoting,  
Effective 04.02.2025*

# Coat Trees

Items below are exempt from surcharge



2112



2113

Model	Description	Size	List	Est. Ship Weight
2112	Coat Tree - 2" Square wood column & base 4 Natural Anodized Aluminum hooks (Model 2081AL) <i>Specify Wood Finish.</i>	69"h x 25"dia	\$924	25*
2113	Coat Tree - 2" Square wood column & base 6 black wood arms w/ rounded tips <i>Specify Wood Finish.</i>	69"h x 25"dia	\$744	25*

^UPS Dimensional Weight Shipped by Truck\*

### To Order Specify

- Quantity
- Model
- Finishes (where applicable)

#### Finishes - Models 2112 - 2113

<b>CH</b> Cherry	<b>MM</b> Mahogany
<b>LC</b> Light Cherry	<b>LW</b> Light Walnut
<b>HO</b> Honey	<b>W</b> Walnut
<b>MA</b> Natural Maple	<b>EB</b> Ebony

# Hat & Coat Hooks

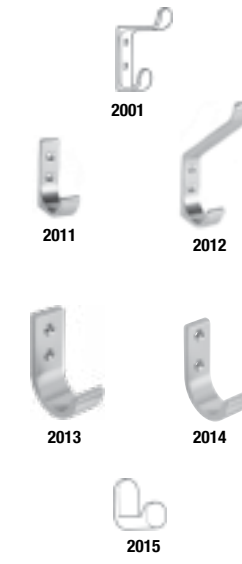

2001

2011

2012

2013

2014

2015

### Finishes

Model	Description	Size	A	AL	BL	H	SH
2001	aluminum	¾"w x 3 ¾"h x 3"d		\$144			
2011	brass	¾"w x 2 ½"h x 2"d		\$28	\$31		
2012	aluminum	¾"w x 5 ¼"h x 2"d		\$41	\$46		
2013	aluminum	1"w x 2 ¾"h x 2"d		\$42	\$44		
2014	aluminum	5/8"w x 2"h x 1 ½"d		\$35	\$39		
2015	brass	¾"w x 1 ½"h x 1 5/8"d				\$128	\$174
<b>Option</b>							
2999	wall anchor option (price per each)			\$2			

Single Hook Prices.  
See page 71 for Mounting Bar prices.  
Wood screws included.  
Coat Hook base material is aluminum unless otherwise specified.

### To Order Specify

- Quantity
- Model
- Finish
- Option

#### Finishes

<b>A</b>	PPP Color
<b>AL</b>	Polished Aluminum, Natural Anodized
<b>BL</b>	Anodized Aluminum, Black
<b>H</b>	Polished Chrome
<b>SH</b>	Satin Chrome

See PPP Color Card or Web











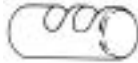

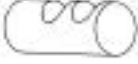
©11/2024

©11/2024









# Hat & Coat Hooks

Model	Description	Size	Finishes		
			AL	H	SS
 2020	brass	¾"dia x 1 ½"d		\$86	
 2023	aluminum	1 ½" dia x 3 3/8"d	\$113	\$126	
 2024	aluminum	1 ½"dia x 2 ¼"d	\$99	\$112	
 2025	aluminum	1 ½"dia x 3 ¾"d	\$114	\$126	
 2026	aluminum	1 ½"dia x 2 ½"d	\$99	\$112	
 2028	stainless steel	½"w x 3"h x 2"d			\$69
 2029	polished stainless steel	1"w x 2"d			\$65
 2032	aluminum	1"dia x 1 ¾"d	\$88	\$95	
 2033	aluminum	1"dia x 2 ¾"d	\$93	\$104	
 2034	aluminum	1"dia x 1 5/8"d	\$88	\$95	
 2035	aluminum	1"dia x 3"d	\$93	\$104	
<b>Option</b>					
2999	wall anchor option (price per each)		\$2		
<p>Single Hook Prices. See page 71 for Mounting Bar prices. Wood screws included. Coat Hook base material is aluminum unless otherwise specified.</p>					
<b>To Order Specify</b>					
<ol style="list-style-type: none"> <li>Quantity</li> <li>Model</li> <li>Finish</li> <li>Option</li> </ol>			<p><b>Finishes</b></p> <p><b>AL</b> Polished Aluminum, Natural Anodized  <b>H</b> Polished Chrome  <b>SS</b> Stainless Steel</p> <p>See Web</p>		



# Hat & Coat Hooks

Model	Description	Size	Finishes		
			AL	H	
 2036	aluminum	1"dia x 1 ¾"d	\$88	\$95	
 2038	brass	¾"dia x 1 ½"d	\$0	\$129	
 2039	aluminum	1"dia x 2 ½"d	\$93	\$104	
 2040XL	aluminum	1"dia x 2 ½"d	\$93	\$104	
 2041	aluminum	1 ¼"dia x 2 3/8"d	\$99	\$104	
 2042	aluminum	1 ½"dia x 2 ½"d	\$93		
<b>Option</b>					
2999	wall anchor option (price per each)			\$2	
<p>Single Hook Prices. See page 71 for Mounting Bar prices. Wood screws included. Coat Hook base material is aluminum unless otherwise specified.</p>					
<b>To Order Specify</b>					
<ol style="list-style-type: none"> <li>Quantity</li> <li>Model</li> <li>Finish</li> <li>Option</li> </ol>			<p><b>Finishes</b></p> <p><b>AL</b> Polished Aluminum, Natural Anodized  <b>H</b> Polished Chrome</p> <p>See Web</p>		

©11/2024

©11/2024



# Hat & Coat Hooks

Model	Description	Size	Finishes	
			AL	BL
2060	aluminum, magnetic attachment. capacity 13lbs	¾"w x 3"h x 1 9/16"d	\$85	\$85
2070	aluminum	¾"w x 1 11/16"h x 2"d	\$47	\$54
2071	aluminum	1 ¼"w x 4"h x 1 ½"d	\$39	\$41
2072	aluminum	1 ¼"w x 2 ¼"h x 2"d	\$30	
2073	aluminum	1 ¾"w x 5 ¼"h x 3 3/8"d	\$54	
2075	aluminum	1 ½"w x 2"h x 2 3/8"d	\$50	
2076	aluminum	1 ½"w x 2"h x 2 ½"d	\$41	
2077	aluminum	3"w x 1 ¾"h x 2 5/8"d	\$46	\$54
2078	aluminum	3"w x 5 ½"h x 3 ½"d	\$64	\$75
2079	aluminum	¾"w x 4"h x 3 ½"d	\$51	\$60
2081	aluminum	2 ¾"w x 4"h x 3 ½"d	\$61	
2082	aluminum	¾"w x 1 ¾"h x 1 5/8"d	\$28	
2083	aluminum w/ rubber door-stop tip	¾"w x 2"h x 3 1/8"d	\$41	
<b>Option</b>				
2999	wall anchor option (price per each)		\$2	

Single Hook Prices.  
See page 71 for Mounting Bar prices.  
Wood screws included.  
Coat Hook base material is aluminum unless otherwise specified.

To Order Specify	
1. Quantity	<b>Finishes</b> <b>AL</b> Polished Aluminum, Natural Anodized <b>BL</b> Epoxy Coated Aluminum, Black Model 2071 ONLY: Anodized Aluminum, Black  See Web
2. Model	
3. Finish	
4. Option	

# Wood Mounting Bar For Pre-Mounted Multiple Hooks

Items below are exempt from surcharge

Model	Description	Size	List	Est. Ship Weight
1	Small Wood Mounting Bar - to be completed with 2 hooks	12"w x 2"h x ½"d	\$119	2
2	Large Wood Mounting Bar - to be completed with 4 hooks	24"w x 2"h x ½"d	\$182	3

Note: Above prices are for bars ONLY.  
For Hooks & Prices, see pages 67-70.

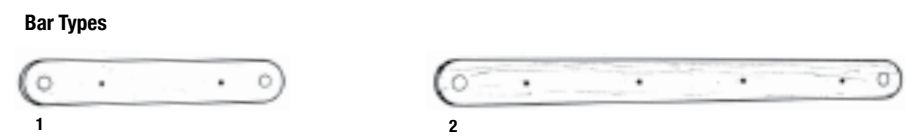









To Order Specify	
1. Bar Quantity 2. Model TYPE+Bar Type Number 3. Bar Finish Code 4. Hook Quantity 5. Hook Model 6. Hook Finish	<b>Bar Finishes</b> <b>A</b> PPP Color <b>CH</b> Cherry <b>LC</b> Light Cherry <b>HO</b> Honey <b>MA</b> Natural Maple <b>MM</b> Mahogany <b>LW</b> Light Walnut <b>W</b> Walnut
Note: Above prices are for bars ONLY. For Hooks & Prices, see pages 67-70.  See PPP Color Card or Web	

**Specifications**

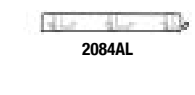
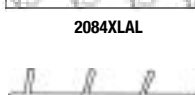
- Mounting method for Wood Bar Types 1 - 2:  
 Flush-fit, metal disc, mounting-hole cover in compatible finish to hooks.  
 Wall mounting hardware included.  
 Due to base design of certain hook models, the bar height will be increased proportionately.  
 Wood mounting bars are available in custom lengths, maximum 8 ft. length. \$67 per lineal foot, round to next foot, PLUS the price of hooks.

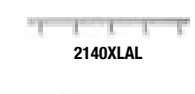
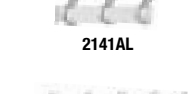
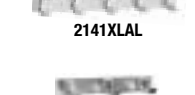

## Hat & Coat Hooks Mounted on Aluminum Bars

Model	Description	Size	List	Est. Ship Weight
 2043AL	Coat Rack w/ 3 hooks on bar	16"w x 5"h x 3 3/4"d	\$284	3
 2043XLAL	Coat Rack w/ 4 hooks on bar	22 3/8"w x 5"h x 3 3/4"d	\$367	4
 2084AL	Coat Rack w/ 3 hooks on bar	16"w x 2"h x 2 3/4"d	\$280	2
 2084XLAL	Coat Rack w/ 4 hooks on bar	22 3/8"w x 2"h x 2 3/4"d	\$353	4
 2085AL	Coat Rack w/ 4 hooks on bar	22 3/8"w x 4 1/2"h x 3 3/4"d	\$474	4
 2086AL	Coat Rack w/ 4 hooks on bar	22 3/8"w x 5"h x 4"d	\$474	4
 2088AL	Coat Rack w/ 3 hooks on bar	16"w x 4 1/2"h x 3 3/4"d	\$353	4
 2140XLAL	Coat Rack w/ 5 hooks on a half round bar. Screw Mount.	14 3/4"w x 7/8"h x 1 1/2"d	\$208	3
 2141AL	Coat Rack w/ 3 hooks on a flush plate. Screw Mount.	8 1/4"w x 4"h x 2 3/4"d	\$138	3
 2141XLAL	Coat Rack w/ 5 hooks on a flush plate. Screw Mount.	14 1/4"w x 4"h x 2 3/4"d	\$209	4
 2142AL	Coat Rack w/ 3 hooks on a flush plate. Screw Mount.	8 1/4"w x 1 3/8"h x 1 3/4"d	\$130	2
 2142XLAL	Coat Rack w/ 5 hooks on a flush plate. Screw Mount.	14 1/4"w x 1 3/8"h x 1 3/4"d	\$158	4





### To Order Specify

- Quantity
- Model

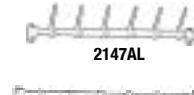
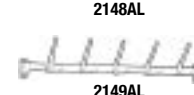

### Specifications

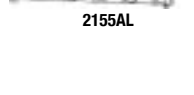
- Natural Anodized Aluminum.
- Bars: Extruded aluminum.
- Keyhole mount unless stated otherwise.
- Wall mounting hardware included.

## Hat & Coat Racks With Hooks or Hangers • Wall Mounted Umbrella Stands

Model	Description	Size	List	Est. Ship Weight
 2147AL	Hat & Coat Hook Bar w/ 6 Hooks - hooks can slide or be locked in position.	32"w x 6"h x 4 1/2"d	\$719	5
 2148AL	Hat & Coat Hook Bar w/ 6 Hooks - hooks can slide or be locked in position.	32"w x 3"h x 3 3/4"d	\$580	5
 2149AL	Hat & Coat Hook Bar w/ 5 Hooks - hooks can slide or be locked in position.	32"w x 3"h x 4"d	\$559	5
 2150AL	Hat & Coat Hook Bar w/ 5 Hooks - hooks can slide or be locked in position.	32"w x 6 1/2"h x 11"d	\$1,483	7
 2155AL				

Model	Description	Size	List	Est. Ship Weight
 2067	Umbrella Stand - Polished tubular steel, .065 thick with electro-welded seam	20"h x 10"dia	\$555	26
 222U	Umbrella Stand - Lock seam steel w/ square perforated holes	14 1/2"h x 10"dia	\$376	8
 224U	Umbrella Stand - Lock seam steel w/ square perforated holes	19"h x 10"dia	\$445	8

### Umbrella Stands

### To Order Specify

- Quantity
- Model
- Finishes

### Specifications

- Natural Anodized Aluminum.
- End Caps & Coat Hooks: Die-cast aluminum.
- Bars: Extruded aluminum.

- Custom lengths available in contract quantities. Please submit your requirements.
- Wall mounting hardware included.

Shipped by Truck\*  
Shipped in 2 boxes  
Shipped KD  
FOB Commerce



**PRICE LIST & SPECIFICATIONS**

Effective January 1, 2026

All Prices are Suggested List Price

Updated 11.03.25

**Section 4**

**FIBERGLASS & STEEL PRODUCTS**

**Steel & Stainless Recycling Containers**

Trash & Recycling Receptacles

Wastebaskets

Recycling Bins

**Fiberglass Trash & Recycling Receptacles**

Recycling Centers

Trash Receptacles

**Fiberglass Planters**

**Fiberglass Drum Tables**



**Wastebaskets • Cylindrical Steel  
Recycling Bins • Stainless Steel**

Items below are exempt from surcharge



663



282

©11/2024

©11/2024

**15% Surcharge  
On This Category  
Until Further Notice**  
*Please apply to product in  
this pricelist when quoting.  
Effective 04.02.2025*

Wastebaskets - Cylindrical Steel			
Model	Description	Size	Est. Ship Weight
662	Steel wastebasket	10"dia x 15"h	15^
663	Steel wastebasket	10"dia x 12"h	12^
<b>Option Plastic Bag Retainer</b>			1
281	Wastebasket with black top ring	10"dia x 20"h	21
282	Wastebasket with black top ring	10"dia x 24"h	32
283	Wastebasket with black top ring	10"dia x 28"h	37

^UPS Dimensional Weight

To Order Specify	
1. Quantity	<b>Finish</b> A PPP Color <i>See PPP Color Card or Web</i>
2. Model	
3. Finish	
4. Options	

- Specifications**
- PPP Color interior same color as exterior (Models 281-283, 662 & 663).
  - Polished tubular steel, .065 thick with electro-welded seams (Models 281-283, 662 & 663).





**Wastebaskets • Cylindrical Steel**  
**Recycling Bins • Stainless Steel**  
**Tria Bin • Fiberglass**



222

Wastebaskets - Cylindrical Steel			
Model	Description	Size	Est. Ship Weight
222	Wastebasket lock seam steel with square perforated holes	10" dia x 14 1/2" h	5
224	Wastebasket lock seam steel with square perforated holes Available in Aluminum Metallic powder coat only	10" dia x 19" h	13
<b>Option</b> Plastic Bag Retainer			1

^UPS Dimensional Weight

To Order Specify	
1. Quantity	
2. Model	
3. Options	



TRB2438

Tria Bin <i>Designed by Andrea Ruggiero</i>				
Model	Description	Size	Container Capacity (gallons)	Est. Ship Weight
TRB2438	Tria Trash Bin - Top Opening 8" dia. Molded bag retainer included.	24" dia x 38" h	20 gal	40*

Shipped by Truck\*  
 FOB Toronto, Canada

To Order Specify	
1. Quantity	<b>Matte Gel-Coat Finish</b> PPP Color <i>See PPP Color Card or Web</i>
2. Model	
3. Finish	

- Specifications**
- Fiberglass.
  - Matte Gel-Coat polyurethane post finish in any PPP Color.
  - Indoor/outdoor use.
  - See page 86 for complete Fiberglass Specifications.



**Fiberglass Recycling Centers**

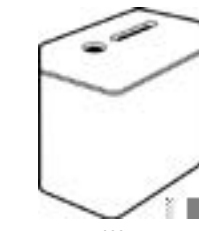

1035  
 Shown with 'A' top configuration



1037  
 Shown with 'C' top configuration

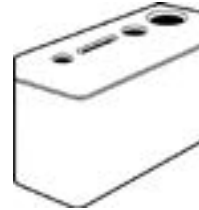

1039  
 Shown with 'F' top configuration

Model	Description	Size	Container Capacity (gallons)	PPP Color	Liner Charge	Est. Ship Weight
1034	Recycling Center, 2 Openings. Fiberglass liners optional.	36" w x 28" h x 16" h	23 gal (x2)	\$2,754	\$583	44-54*
1035	Recycling Center, 2 Openings. Fiberglass liners optional.	36" w x 32" h x 16" h	26 gal (x2)	\$2,941	\$583	50-60*
1035S	Recycling Center, 2 Openings. (R) Top Only. Fiberglass liners optional.	24" w x 32" h x 16" d	16 gal (x2)	\$1,976	\$583	46-56*
1036	Recycling Center, 3 Openings. Fiberglass liners optional.	36" w x 28" h x 16" h	17 gal (x3)	\$2,754	\$875	52-67*
1037	Recycling Center, 3 Openings. Fiberglass liners optional.	36" w x 32" h x 16" h	19 gal (x3)	\$2,941	\$875	45-60*
1039	Recycling Center, 4 Openings. Fiberglass liners optional.	48" w x 32" h x 16" h	19 gal (x4)	\$3,543	\$1,166	60-80*
1039	Recycling Center, 3 Openings. (K) Top Only. Fiberglass liners optional.	48" w x 32" h x 16" h	19 gal (x3)	\$3,543	\$875	60-80*

Shipped by Truck\*  
 FOB Toronto, Canada

**Specifications & Ordering Information (See page 86)**



© 11/2024

© 11/2024





# Fiberglass Recycling Centers Specifications



# Fiberglass Recycling Receptacles Square • Cylindrical

## Available Top Configurations for Models 1034 - 1039

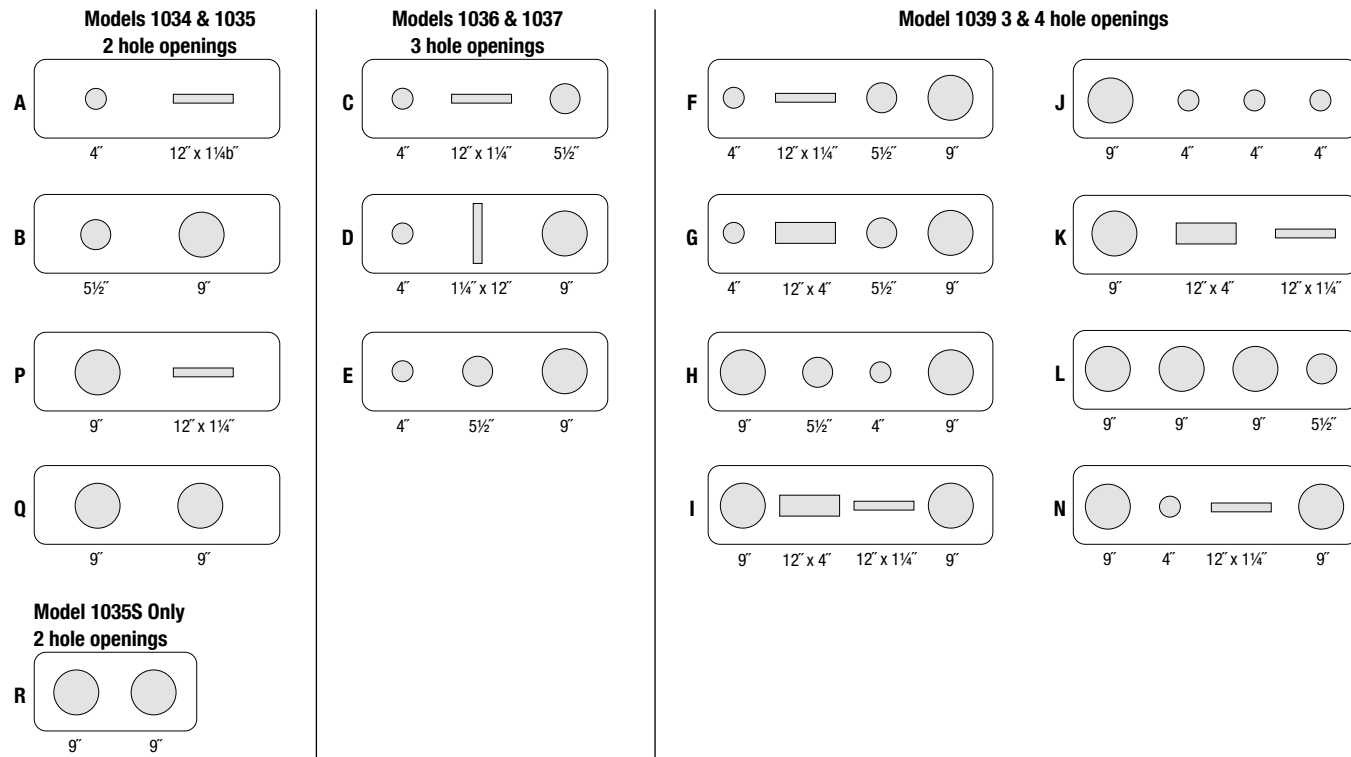

Illustrations not to scale. FOB Toronto, Canada

- M 1034-1035  
1036-1037
- O 1039

**Custom Openings & Configurations**  
On PPP Color models only. Add 10% Upcharge. Custom-Cut Option: *Specify size & sequence from standard sizes shown. M & O custom openings have black vinyl trim around cutouts.*

**To Order Specify** (For detailed specifications, See page 86)

<ol style="list-style-type: none"> <li>Quantity</li> <li>Model</li> <li>Top Opening</li> <li>Finish</li> <li>Recycling Decal Color</li> <li><b>Options:</b> Fiberglass Liners</li> </ol>	<b>Finishes</b> <b>Gel-Coat</b> Hi-Gloss PPP Color Metallic PPP Color	<b>Top Openings</b>  For Cans, Glass, Plastic, Waste, Paper
--	--	---

- Specifications**
- Includes set of Recycling Decals. White or Black. Decals: Cans, Glass, Plastic, Waste, Paper and
  - Suitable for recycling Paper, Cans, Glass, Plastic and Trash.
  - One-piece top lifts off for easy access.
  - Individual, standard size plastic bags attach to interior wall.
  - Additional set of Recycling Decals, White or Black. List \$70.
  - Anchoring Hardware. \$85 NET.

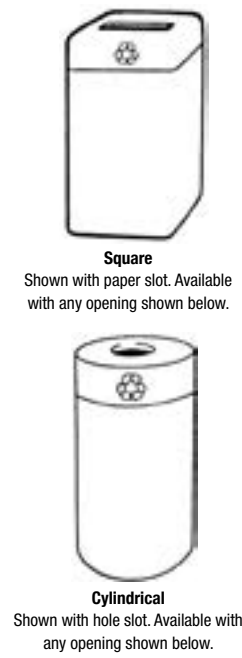

Model	Description	Size	Container Capacity (gallons)	PPP Color	Liner Charge	Est. Ship Weight
1031	Square Recycling Receptacle	16"sq x 28"h	22 gal	\$1,364	\$300	33-39*
1032	Square Recycling Receptacle	20"sq x 32"h	42 gal	\$1,692	\$352	39-47*
1033	Square Recycling Receptacle	20"sq x 36"h	42 gal	\$1,784	\$352	36-44*
1041	Cylindrical Recycling Receptacle	16"dia x 28"h	17	\$1,048	\$300	24-30*
1042	Cylindrical Recycling Receptacle	18"dia x 28"h	23	\$1,211	\$352	26-33*
1043	Cylindrical Recycling Receptacle	18"dia x 32"h	24	\$1,291	\$352	29-36*
1044	Cylindrical Recycling Receptacle	21"dia x 32"h	38	\$1,521	\$352	36-44*
1045	Cylindrical Recycling Receptacle	21"dia x 36"h	38	\$1,616	\$352	44-52*
1046	Cylindrical Recycling Receptacle	24"dia x 32"h	46	\$1,732	\$352	41-51*
1047	Cylindrical Recycling Receptacle	24"dia x 36"h	46	\$1,837	\$352	37-47*

Shipped by Truck\*  
FOB Toronto, Canada

**To Order Specify** (For detailed specifications, See page 86)

<ol style="list-style-type: none"> <li>Quantity</li> <li>Model</li> <li>Top Opening</li> <li>Finish</li> <li><b>Options:</b> Fiberglass Liners</li> </ol>	<b>Finishes</b> <b>Gel-Coat</b> Hi-Gloss PPP Color	<b>Top Openings</b>  For Cans, Glass, Plastic, Waste, Paper
---	--	---

- Specifications**
- Includes set of Recycling Decals. White or Black. Decals: Cans, Glass, Plastic, Waste, Paper and
  - Suitable for recycling Paper, Cans, Glass, Plastic and Trash.
  - One-piece top lifts off for easy access.
  - Individual, standard size plastic bags attach to interior wall.
  - Additional set of Recycling Decals, White or Black. List \$70.
  - Anchoring Hardware. \$85 NET.

# Fiberglass Trash Receptacles

Montreal • Spiral • Liberty • Fanfare®



1228T



1060



1065



1070



1078

Model	Description	Size	Container Capacity (gallons)	PPP Color	Liner Charge	Est. Ship Weight
1224T	Trash Receptacle - 10" dia opening w/ black anodized aluminum ring. Optional Fiberglass Liner.	12" dia x 24" h	7 gal	\$487	\$243	13-17*
1128T	Trash Receptacle - 10" dia opening w/ black anodized aluminum ring. Optional Fiberglass Liner.	12" dia x 28" h	7 gal	\$523	\$243	18-22*
1060	Montreal Trash Receptacle. Fiberglass liner included.	24" dia x 28" h	26 gal	\$1,539	N/A	40*
1061	Montreal Trash Receptacle. Fiberglass liner included.	24" dia x 34" h	28 gal	\$1,767	N/A	45*
1065	Spiral Trash Receptacle. Fiberglass liner included.	20" dia x 32" h	26 gal	\$1,539	N/A	33*
1070	Liberty Trash Receptacle. With built-in bag retainer.	24" dia x 30" h	30 gal	\$1,736	N/A	38*
1071	Liberty Trash Receptacle. With built-in bag retainer.	30" dia x 36" h	48 gal	\$2,551	N/A	57*
1078	Fanfare Trash Receptacle. With built-in bag retainer.	21" dia x 28" h	42 gal	\$1,444	N/A	41*
1079	Fanfare Trash Receptacle. With built-in bag retainer.	23" dia x 33" h	50 gal	\$1,678	N/A	58*

Shipped by Truck\*  
FOB Toronto, Canada

Liberty & Fanfare Cross-Section  
Illustrating Hidden Plastic Bag



### Specifications & Ordering Information (See page 86)

**Finishes**  
PPP Color



# Fiberglass Trash Receptacles



1084



1093



1098



1098WX  
Wall-mounted

Model	Description	Size	Container Capacity (gallons)	PPP Color	Liner Charge	Est. Ship Weight
1084	Trash Receptacle - 11 3/4" dia trash opening. Fiberglass liner included.	18" dia x 31" h	24 gal	\$1,572	N/A	31*
1092	Trash Receptacle - 11" dia trash opening. Optional fiberglass liner.	16" dia x 28" h	17 gal	\$993	\$292	24-6*
1093	Trash Receptacle - 13" dia trash opening. Optional fiberglass liner.	18" dia x 32" h	24 gal	\$1,161	\$292	34-7*
1093S	Trash Receptacle - 13" dia trash opening. Optional fiberglass liner.	18" dia x 22" h	17 gal	\$1,077	\$292	30-7*
1096	Trash Receptacle - 8 1/2" dia trash opening. Optional fiberglass liner.	12" dia x 22" h	7 gal	\$770	\$243	12-4*
1089±	Trash Receptacle - (2x) 8" x 14" side openings. Optional fiberglass liner.	21" dia x 44" h	38 gal	\$1,886	\$334	40-48*
1089X	Trash Receptacle - (2x) 8" x 14" side openings w/ spring loaded flap doors. Optional fiberglass liner. <i>Model 1089UX 'Trash &amp; Ash', see page 85</i>	21" dia x 44" h	38 gal	\$2,280	\$334	44-52*
1097±	Trash Receptacle - (2x) 5" x 8" side openings. Optional fiberglass liner.	12" dia x 25" h	7 gal	\$913	\$243	17-21*
1098±	Trash Receptacle - (2x) 7" x 14" side openings. Optional fiberglass liner. <i>Model 1098U 'Trash &amp; Ash', see page 85</i>	18" dia x 38" h	24 gal	\$1,359	\$292	32-39*
1098X	Trash Receptacle - (2x) 7" x 14" side openings w/ spring loaded flap doors. Optional fiberglass liner.	18" dia x 38" h	24 gal	\$1,751	\$292	37-44*
1098WL	Trash Receptacle - (1x) 7" x 14" side opening. Wall mounted. Fiberglass liner included.	18" w x 38" h x 12" d	12 gal	\$1,244	N/A	43*
1098WX	Trash Receptacle - (1x) 7" x 14" side opening w/ spring loaded flap doors. Wall mounted. Fiberglass liner included.	18" w x 38" h x 12" d	12 gal	\$1,574	N/A	44*

### Option

Black Vinyl Trim for Trash Openings

On request. No upcharge.

Shipped by Truck\*  
FOB Toronto, Canada

### Specifications & Ordering Information (See page 86)

**Finishes**  
PPP Color

### Specifications

Models 1092, 1093, 1093S, 1096, 1089, 1089X, 1097, 1098, 1098X

- Individual, standard size plastic bags attach to interior wall.



# Fiberglass Trash Receptacles • Square Combination Receptacles



1082



1083SX  
With flap doors



1098U

Model	Description	Size	Container Capacity (gallons)	PPP Color	Liner Charge	Est. Ship Weight
<b>Fiberglass Trash Receptacles</b>						
1082±	Trash Receptacle - (2x) 8" x 11" side openings. Optional fiberglass liner.	16"sq x 40"h	22 gal	\$2,095	\$292	34-41*
1083	Trash Receptacle - (2x) 8" x 14" side openings. Optional fiberglass liner.	22"sq x 48"h	46 gal	\$3,722	\$334	52-60*
1083SX	Trash Receptacle - (2x) 8" x 14" side openings w/ spring loaded flap doors. Optional fiberglass liner.	22"sq x 40"h	36 gal	\$3,441	\$334	55-63*
<b>Combination Receptacles</b>						
1089UX	Trash & Ash' Receptacle - (2x) 8" x 14" side openings w/ spring loaded flap doors, with 11" recessed black anodized sand dish. Optional fiberglass liner. <i>Model 1089X 'Trash Receptacle Only', see page 84</i>	21"sq x 44"h	38 gal	\$2,405	\$334	45-53*
1098±	Trash & Ash' Receptacle - (2x) 7" x 14" side openings with 11" recessed black anodized sand dish. Optional fiberglass liner. <i>Model 1098 'Trash Receptacle Only', see page 84</i>	18"sq x 39"h	24 gal	\$1,476	\$292	33-40*
<b>Option</b>						
Black Vinyl Trim for Trash Openings			On request. No upcharge.			

Shipped by Truck\*  
FOB Toronto, Canada

### Specifications & Ordering Information (See page 86)

**Finishes**  
PPP Color

### Specifications

- Individual, standard size plastic bags attach to interior wall.

# Fiberglass Planters Tria • Montreal • Kettle • Tapered



TRP2420

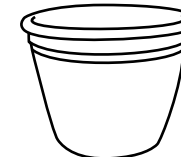

Montreal



Kettle



Tapered

**Tria Planters** *Designed by Andrea Ruggiero*

Model	Description	Size	Opening Size	Base Diameter	Matte PPP Color	Est. Ship Weight
TRP2016	Tria Planter	20"dia x 16"h	15"	10"	\$1,235	16^
TRP2420	Tria Planter	24"dia x 20"h	18"	12"	\$1,480	24^
TRP3024	Tria Planter	30"dia x 24"h	22"	16"	\$1,990	33^

^UPS Dimensional Weight  
FOB Toronto, Canada

### To Order Specify

- Quantity
- Model
- Finish

**Matte Gel-Coat Finish**  
PPP Color

See PPP Color Card or Web

### Specifications

- Fiberglass.
- Matte Gel-Coat polyurethane post finish in any PPP Color or Matte Metallic finishes.
- Indoor/outdoor use.
- See page 86 for complete Fiberglass Specifications.

Model	Description	Size	Opening Size	Base Diameter	PPP Color	Est. Ship Weight
MT2014	Montreal Planter	20"dia x 14"h	17"dia	12"dia	\$620	20^
MT2417	Montreal Planter	24"dia x 17"h	21"dia	14"dia	\$951	32^
MT3021	Montreal Planter	30"dia x 21"h	27"dia	18"dia	\$1,397	25^
MT3625	Montreal Planter	36"dia x 25"h	32"dia	22"dia	\$1,863	36*
MT4230	Montreal Planter	42"dia x 30"h	38"dia	26"dia	\$3,225	60*
MT4834	Montreal Planter	48"dia x 34"h	44"dia	29"dia	\$4,420	87*
K2014	Kettle Planter	20"dia x 14"h	15 1/2"dia	11 1/2"dia	\$591	20
K2416	Kettle Planter	24"dia x 16"h	18 3/4"dia	14"dia	\$932	22
K3020	Kettle Planter	30"dia x 20"h	23 1/2"dia	17 1/2"dia	\$1,289	17
T2016	Tapered Planter	20"dia x 16"h	15"dia	11 1/2"dia	\$616	20^
T2420	Tapered Planter	24"dia x 20"h	18"dia	14"dia	\$988	24^
T3025	Tapered Planter	30"dia x 25"h	23"dia	18"dia	\$1,308	25*

^UPS Dimensional Weight Shipped by Truck\*  
FOB Toronto, Canada

### Specifications & Ordering Information (See page 86)

**Finishes**  
PPP Color



© 11/2024

© 11/2024



# Fiberglass Planters

Cylindrical • Square • Curvilinear • Table Top



Cylindrical



Top view



Square



Top view



Curvilinear



Table Top

Model	Description	Size	Opening Size	PPP Color	Est. Ship Weight
C1212	Cylindrical Planter	12" dia x 12"d	9 3/4" dia	\$277	8
C1424	Cylindrical Planter	14" dia x 24"d	11 1/4" dia	\$515	11^
C1612	Cylindrical Planter	16" dia x 12"d	13 3/4" dia	\$369	9^
C1616	Cylindrical Planter	16" dia x 16"d	13 3/4" dia	\$385	14^
C1620	Cylindrical Planter	16" dia x 20"d	13 3/4" dia	\$485	16^
C1624	Cylindrical Planter	16" dia x 24"d	13 3/4" dia	\$541	18^
C1814	Cylindrical Planter	18" dia x 14"d	15 1/2" dia	\$426	20^
C1818	Cylindrical Planter	18" dia x 18"d	15 1/2" dia	\$496	21^
C1824	Cylindrical Planter	18" dia x 24"d	15 1/2" dia	\$634	23^
C2018	Cylindrical Planter	20" dia x 18"d	17 3/4" dia	\$547	22^
C2020	Cylindrical Planter	20" dia x 20"d	17 3/4" dia	\$604	18^
C2024	Cylindrical Planter	20" dia x 24"d	17 3/4" dia	\$701	20^
C2418	Cylindrical Planter	24" dia x 18"d	21" dia	\$845	23^
C2424	Cylindrical Planter	24" dia x 24"d	21" dia	\$988	28^
C3016	Cylindrical Planter	30" dia x 16"d	26 1/2" dia	\$921	24^
C3020	Cylindrical Planter	30" dia x 20"d	26 1/2" dia	\$981	32^
C3024	Cylindrical Planter	30" dia x 24"d	26 1/2" dia	\$1,073	33^
C3030	Cylindrical Planter	30" dia x 30"d	26 1/2" dia	\$1,257	35*
S181818	Square Planter	18"sq x 18"h	15 3/4"sq	\$644	13^
S242424	Square Planter	24"sq x 24"h	21"sq	\$1,313	32^
S303030	Square Planter	30"sq x 30"h	26 1/2"sq	\$1,928	49*
R127212	Curvilinear Planter	12"w x 72"d x 12"d	9 3/4" x 69 3/4"	\$1,796	27*
R164816	Curvilinear Planter	16"w x 48"d x 16"d	13 1/4" x 45"	\$1,342	27^
R247218	Curvilinear Planter	24"w x 72"d x 18"d	18" x 68"	\$3,943	70*
R101007	Rimless Solid Table Top	10"sq x 7"h		\$269	6

^UPS Dimensional Weight Shipped by Truck\*  
FOB Toronto, Canada

### Specifications & Ordering Information (See page 86)

Finishes  
PPP Color

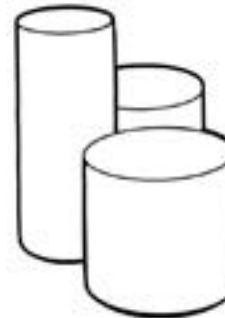

Cylindrical



Curvilinear

# Fiberglass Drum Tables

Cylindrical • Curvilinear

Model	Description	Size	PPP Color	Est. Ship Weight
DT1618	Cylindrical Drum Table	16" dia x 18"h	\$613	17^
DT1621	Cylindrical Drum Table	16" dia x 21"h	\$701	18^
DT1624	Cylindrical Drum Table	16" dia x 24"h	\$772	19^
DT2015	Cylindrical Drum Table	20" dia x 15"h	\$681	18^
DT2018	Cylindrical Drum Table	20" dia x 18"h	\$760	21^
DT2021	Cylindrical Drum Table	20" dia x 21"h	\$854	23^
DT2024	Cylindrical Drum Table	20" dia x 24"h	\$949	27^
DT2415	Cylindrical Drum Table	24" dia x 15"h	\$916	29^
DT2418	Cylindrical Drum Table	24" dia x 18"h	\$1,008	30^
DT2421	Cylindrical Drum Table	24" dia x 21"h	\$1,090	31^
DT2424	Cylindrical Drum Table	24" dia x 24"h	\$1,174	34^
DT3015	Cylindrical Drum Table	30" dia x 15"h	\$1,080	39^
DT3018	Cylindrical Drum Table	30" dia x 18"h	\$1,177	42^
DT3021	Cylindrical Drum Table	30" dia x 21"h	\$1,326	43^
DT3024	Cylindrical Drum Table	30" dia x 24"h	\$1,398	45^
DT3615	Cylindrical Drum Table	36" dia x 15"h	\$1,249	52*
DTR202015	Curvilinear Drum Table	20"sq x 15"h	\$903	22^
DTR202018	Curvilinear Drum Table	20"sq x 18"h	\$932	26^
DTR202021	Curvilinear Drum Table	20"sq x 21"h	\$962	27^
DTR242415	Curvilinear Drum Table	24"sq x 15"h	\$1,519	35^
DTR242418	Curvilinear Drum Table	24"sq x 18"h	\$1,569	38^
DTR242421	Curvilinear Drum Table	24"sq x 21"h	\$1,636	39^

^UPS Dimensional Weight Shipped by Truck\*  
FOB Toronto, Canada

### Specifications & Ordering Information (See page 86)

Finishes  
PPP Color



© 11/2024

© 11/2024



# Fiberglass Products Specifications & Ordering Information

**All Fiberglass products are shipped FOB Toronto, Canada.**  
Freight Class 100.

### Fiberglass Specifications

- Products are made with multiple layers of random chopped fiberglass in conjunction with thermosetting polyester resins.
- Ideal for interior or exterior use.
- All products are molded of general purpose polyester resin, with a flame spread greater than > 75.
- Plastic properties conform to Society of Plastics Industry recommendations.
- Products are integrally surfaced with a molded gel-coat of uniform color and thickness.
- Parting lines and trimmed sections are finished to eliminate sharp edges.

### Finishes

#### PPP Color • Hi-Gloss Gel-Coat

- Available in any PPP Color. *See PPP Color Card or Web.*

#### Tria Models ONLY: PPP Color • Matte Gel-Coat

- Matte Gel-Coat polyurethane post finish in any PPP Color. *See Web.*

### Options

Fiberglass trash liner	See Model No. for pricing
Recycling Decals, Black or White Only	\$71
Black Vinyl Trim for Trash Openings	On request. No upcharge.
Trim available on PPP Color Models ONLY	Applicable models identifiable with ±
Custom Colors	\$412
Anchoring Hardware	\$85

### To Order Specify

<b>1. Quantity</b>	
<b>2. Model</b>	
<b>3. Finish</b>	<b>Finishes</b>
<b>4. Options</b>	Hi-Gloss: PPP Color
	Matte - Tria Models Only: PPP Color
<i>See PPP Color Card or Web</i>	

### PRICE LIST & SPECIFICATIONS

Effective January 1, 2026

All Prices are Suggested List Price

Updated 11.03.25

©11/2024

©11/2024

**15% Surcharge on  
All Items FOB Toronto  
Until Further Notice**

*Please apply to product in  
this pricelist when specifying.  
Effective 03.03.2025*



# Fiberglass Drum Tables

Cylindrical • Curvilinear

## Section 9

### SHOWCASE COLLECTION

PepperMint® & MiniMint®  
Freestanding  
Wall Mounted  
Counter Top

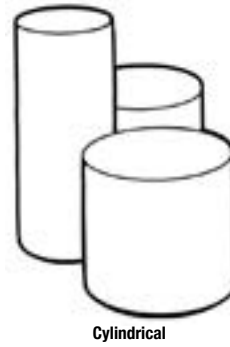

Cylindrical



Curvilinear

Model	Description	Size	PPP Color	Est. Ship Weight
DT1618	Cylindrical Drum Table	16" dia x 18"h	\$613	17^
DT1621	Cylindrical Drum Table	16" dia x 21"h	\$701	18^
DT1624	Cylindrical Drum Table	16" dia x 24"h	\$772	19^
DT2015	Cylindrical Drum Table	20" dia x 15"h	\$681	18^
DT2018	Cylindrical Drum Table	20" dia x 18"h	\$760	21^
DT2021	Cylindrical Drum Table	20" dia x 21"h	\$854	23^
DT2024	Cylindrical Drum Table	20" dia x 24"h	\$949	27^
DT2415	Cylindrical Drum Table	24" dia x 15"h	\$916	29^
DT2418	Cylindrical Drum Table	24" dia x 18"h	\$1,008	30^
DT2421	Cylindrical Drum Table	24" dia x 21"h	\$1,090	31^
DT2424	Cylindrical Drum Table	24" dia x 24"h	\$1,174	34^
DT3015	Cylindrical Drum Table	30" dia x 15"h	\$1,080	39^
DT3018	Cylindrical Drum Table	30" dia x 18"h	\$1,177	42^
DT3021	Cylindrical Drum Table	30" dia x 21"h	\$1,326	43^
DT3024	Cylindrical Drum Table	30" dia x 24"h	\$1,398	45^
DT3615	Cylindrical Drum Table	36" dia x 15"h	\$1,249	52*
DTR202015	Curvilinear Drum Table	20"sq x 15"h	\$903	22^
DTR202018	Curvilinear Drum Table	20"sq x 18"h	\$932	26^
DTR202021	Curvilinear Drum Table	20"sq x 21"h	\$962	27^
DTR242415	Curvilinear Drum Table	24"sq x 15"h	\$1,519	35^
DTR242418	Curvilinear Drum Table	24"sq x 18"h	\$1,569	38^
DTR242421	Curvilinear Drum Table	24"sq x 21"h	\$1,636	39^

#### Option

Custom Colors

\$412

^UPS Dimensional Weight Shipped by Truck\*  
FOB Toronto, Canada

#### To Order Specify

- Quantity
- Model
- PPP Color
- Option

#### Finishes

**Gel-Coat**  
Hi-Gloss: PPP Color

See PPP Color Card or Web

#### Specifications

Fiberglass Drum Tables are shipped freight class 100, FOB Toronto, Canada.

- Products are made with multiple layers of random chopped fiberglass in conjunction with thermosetting polyester resins.
- Products are integrally surfaced with a molded gel-coat of uniform color and thickness.

#### Finishes

PPP Color • Hi-Gloss Gel-Coat

- Available in any PPP Color. See PPP Color Card or Web.

#### PRICE LIST & SPECIFICATIONS

Effective January 1, 2026

All Prices are Suggested List Price

Updated 11.03.25

© 11/2024





© 11/2024

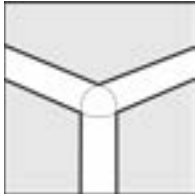
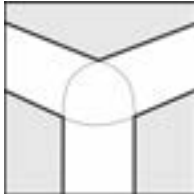

OSHPD Seismic Compliant  
Anchorage in California

# Specifications PepperMint® & MiniMint® Showcase Collection

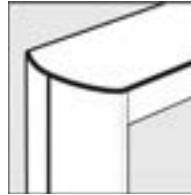
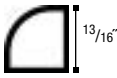
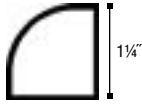
## Aluminum Extrusion Profiles

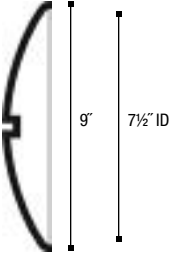
Mini Quarter Round	Quarter Round	Circular	Elliptical
<b>Model</b> MMW	<b>Model</b> PMC-B PMS-E PMC-GL PMS-E-GL PMS-B PMW PMS-GL	<b>Model</b> US USZ USZ-B	<b>Model</b> ESZ ESW-Z ESZ-B ESW-S REW
			
			

## Standard Features

All models are assembled, crated and shipped by truck.

**Frame Finishes:** Natural Anodized Aluminum or PPP Color. Upcharge for PPP Color.

**Glass:** Sliding doors, panels and tops: 5/32" thick tempered glass. Gliding or hinged doors, counter & tops: 1/4" thick tempered glass.

**Adjustable Shelving:** 1/4" thick tempered glass on models thru 42" wide and models 60" to 72" wide with center shelf support. 3/8" thick non-tempered glass on models 48" wide. Exposed edges are polished. Concealed edges cushioned with anti-rattle extrusions.

**All Doors:** Always on width side of showcase, unless otherwise specified.

**Hinged Doors:** On all 24" width models. Plate hinges on models with 48" door height or more.

**Sliding Doors:** On models where door width exceeds 24" and door height is less than 36", except model PMC-GL. Doors slide smoothly in plastic track.

**Gliding Doors:** On PMS models, doors glide on roller bearings, in an aluminum track.

**Locks:** Included on all hinged, sliding and gliding doors.

**Bottom Shelf:** 5/8" thick particle board, melamine finish.

**Wall Mounting Cleat/Bracket:** Included, with hardware.

**Adjustable Foot Glides:** Included on freestanding models.

Plate Hinge



Sliding Door in Plastic Track



Gliding Door in Aluminum Track



Wall Mount

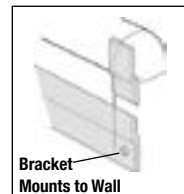

## Panels

Hardboard panels available in any PPP Color. See PPP Color Card.

**COM:** Customer's Own Material. See COM Shipping instructions next page.

# Options

## Plinths

Optional on models PMS, US and USZ.

Black finish standard.

Adjustable foot glides included. Plinth height adds to total height of case.

	List
2" height .....	\$ 219
4" height .....	287
6" height .....	353

## Lockable Casters - 2"

Available on models ES, US, PMS and PMC

Case Width

24" to 48" wide..... Set of 4 .....	333
Over 48" to 72" wide..... Set of 6 .....	419

## Lockable Accessible Storage

Optional on models PMS-B, PMS-E, PMS-E-GL and USZ-B, 24" width or more ..... 389

Includes sliding hardboard door panels with integral key lock. Available in any PPP Color. See PPP Color Card.

## Replacement Lock & Keys

Hinged Doors .....	107
Sliding Doors .....	69
Gliding Doors .....	125

## Replacement Shelf Pins

Specify model ..... 13 ea.

## Replacement Wall Mount Cleat

Top & bottom brackets - Per Lineal Foot ..... 18

## Back Panel

Hardboard back panel: Available in any PPP Color. See PPP Color Card ..... 201

## Grommets - 2"

Please contact factory to specify location ..... 103

## Specials

Custom showcase sizes available. Please submit your requirements to specials@peterpepper.com.

© 11/2024

© 11/2024



# Optional Lighting System Specifications

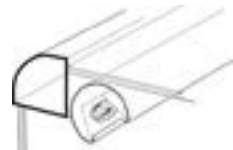

## Linear Lighting, Low Voltage LED

LED lamps are one of the smallest, hi-intensity light sources available. Spaced 9" to 12" apart, this energy-efficient linear lighting provides multiple-point sources for a brighter, whiter light that gives extraordinary brilliance to the merchandise. Ideal for products, awards, trophies, jewelry and glassware displays.

### Mounting

Linear lighting mounted in a 1 1/4" diameter aluminum extrusion at top front of display case, door side unless otherwise specified. The transformer is remotely mounted in base, plinth, soffit or under bottom panel of models PMS-L, PMS-C and PMS-Q.

When ordering models PMS-GL or USZ, specify 4" or 6" plinth for transformer mounting area.

Finishes: Natural Anodized Aluminum.

### Standard Equipment (UL Listed)

Showcase light, downtube, flex, transformer, switch and 6' power cord.

- 2,500 lumens, 137 lpw
- 60 diodes per inch.
- Instant On and Flicker Free
- Lumens: 2000
- Color Temp: 5000
- Warranty: 5 years
- Rated Life: 50,000 Hour Life

### Recommended Lighting

Case Width	Lamp Width	List	Case Width	Lamp Width	List
24" - 30"	18"	\$ 1096	48" - 60"	45"	\$ 1405
36"	33"	1268	72"	70"	1572
42"	39"	1279			

Custom case lighting on request.

## Recessed Lighting, Low Voltage LED

LED lighting system is designed for recessed mounting.

Soffit areas conceal the transformer & fixtures in the top or bottom area of the showcase.

LED lighting provides brighter, whiter light that gives extraordinary brilliance to the merchandise.

Recessed lighting may also be incorporated into custom showcases.

### Mounting

The LED fixtures are equally spaced and recessed into the top inside panel of the display area.

Trim ring is 2 3/4" dia. and extends 1/4" below the finished panel. The top inside panel finish is black.

The transformer is remotely mounted in the soffit area. A 10' power cord exits at the top rear panel of the soffit on models ESW-S, PMW-S, and MMW-S.

On models PMS-E, ESZ, ESZ-B, US, USZ and USZ-B, the cord exits at the bottom of the case.

Not available on Model US (S) Spacer Top.

### Finishes

**Standard finish:** Black. Fixture housings and trim rings are made of high temperature polycarbonate injection molded resin. The reflector system is made of high-grade aluminum, bright-dipped and anodized for maximum performance. The trim rings have a 3mm thick tempered clear glass lens which meets UL requirements.

### Standard Equipment (UL Listed)

12 volt LED lamps, housing with trim rings and transformer with 10' power cord and switch. Additional fixtures available. Please submit your requirements.

### Lighting Specifications

- Bulb: 12 volt LEDP module 60WH-3020 @ 2.4 Watts each module uses 24PCS of 5MM LED's.
- Color Temp: 6000K White.
- Luminous Flux: 150 LM.
- Lifespan: Up to 50,000 hours.
- Transformer: 120 volt, AC, 12 volt secondary @ 1 amp.

### Note

Low voltage LED lamps are low-heat, UV safe and acceptable for museum/archival materials.

### Recommended Lighting

Case Width	No. of Lamps	List	Case Width	No. of Lamps	List
24"	2	\$ 737	60"	5	\$ 1563
30" - 36"	3	944	72"	6	1768
42" - 48"	4	1388			

Custom case lighting on request.

### Models PMS-GL and PMS-B

• Add \$882 List for the addition of a lighting soffit area.

• When ordering model PMS-GL specify a plinth for transformer mounting area.

**PMW-S**  
Illustrated with optional Recessed Lighting. Linear or Fluorescent Lighting also available on PMW-S & MMW-S



# PepperMint® Showcases

Model PMS-GL • All Glass

Model PMS-B • Panel Base



PMS-GL

Illustrated with optional plinth.

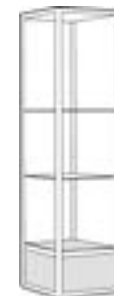

PMS-B

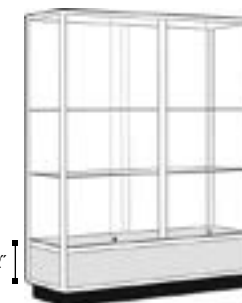

PMS-B, 72" w

Illustrated with 2 sets of gliding doors and optional plinth.

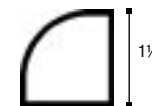

Aluminum Quarter Round

Model	Size	Door Types		[GL]	[B]	Upcharge PPP Color Frame	NET Crafting Charge	Est. Ship Weight
		PMS-GL	PMS-B					
PMS[??]RA247215	24"w x 72"h x 15"d	hinged	hinged	\$6,089	\$6,433	\$609	\$401	213*
PMS[??]RA247218	24"w x 72"h x 18"d	hinged	hinged	\$6,368	\$6,694	\$637	\$420	234*
PMS[??]RA247224	24"w x 72"h x 24"d	hinged	hinged	\$6,930	\$7,085	\$693	\$453	276*
PMS[??]RA307215	30"w x 72"h x 15"d	gliding	gliding	\$6,891	\$7,085	\$689	\$435	252*
PMS[??]RA307218	30"w x 72"h x 18"d	gliding	gliding	\$7,198	\$7,368	\$720	\$453	275*
PMS[??]RA307224	30"w x 72"h x 24"d	gliding	gliding	\$7,816	\$7,946	\$782	\$486	322*
PMS[??]RA363615	36"w x 36"h x 15"d	gliding	gliding	\$5,145	\$4,506	\$515	\$365	164*
PMS[??]RA363618	36"w x 36"h x 18"d	gliding	gliding	\$5,358	\$4,689	\$536	\$383	180*
PMS[??]RA363624	36"w x 36"h x 24"d	gliding	gliding	\$5,777	\$5,062	\$578	\$410	214*
PMS[??]RA367215	36"w x 72"h x 15"d	gliding	gliding	\$7,421	\$7,594	\$742	\$463	286*
PMS[??]RA367218	36"w x 72"h x 18"d	gliding	gliding	\$7,753	\$7,942	\$775	\$483	313*
PMS[??]RA367224	36"w x 72"h x 24"d	gliding	gliding	\$8,423	\$8,519	\$842	\$514	364*
PMS[??]RA427215	42"w x 72"h x 15"d	gliding	gliding	\$7,947	\$8,106	\$795	\$491	322*
PMS[??]RA427218	42"w x 72"h x 18"d	gliding	gliding	\$8,308	\$8,434	\$831	\$841	350*
PMS[??]RA427224	42"w x 72"h x 24"d	gliding	gliding	\$9,032	\$9,098	\$903	\$541	408*
PMS[??]RA487215	48"w x 72"h x 15"d	gliding	gliding	\$9,439	\$9,341	\$944	\$518	389*
PMS[??]RA487218	48"w x 72"h x 18"d	gliding	gliding	\$9,985	\$9,812	\$999	\$535	427*
PMS[??]RA487224	48"w x 72"h x 24"d	gliding	gliding	\$11,082	\$10,758	\$1,108	\$566	505*
PMS[??]RA724818	±72"w x 48"h x 18"d	gliding	gliding	\$10,953	\$10,949	\$1,096	\$553	401*
PMS[??]RA726018	±72"w x 60"h x 18"d	gliding	gliding	\$12,006	\$11,996	\$1,201	\$596	465*
PMS[??]RA727218	±72"w x 72"h x 18"d	gliding	gliding	\$13,659	\$13,652	\$1,366	\$635	548*
PMS[??]RA724824	±72"w x 48"h x 24"d	gliding	gliding	\$11,775	\$11,647	\$1,177	\$584	467*
PMS[??]RA726024	±72"w x 60"h x 24"d	gliding	gliding	\$12,860	\$12,734	\$1,286	\$622	534*
PMS[??]RA727224	±72"w x 72"h x 24"d	gliding	gliding	\$14,689	\$14,562	\$1,469	\$667	630*

Shipped by Truck\*

### Options

Plinth: 2" h, 4" h or 6" h. Black finish. See page 91. Lighting: See page 92.

Lockable Accessible Storage on Model PMS-B

\$388

Hardboard back panel - any PPP Color. Replaces Glass.

\$201

### To Order Specify

1. Quantity
2. Model PMS-GL or PMS-B
3. Frame Finish Code. Upcharge for PPP Color
4. Size: W x H x D
5. PMS-B Panel Base: PPP Color
6. Add NET Crating Charge
7. Options

### Finishes

**RA** Natural Anodized Aluminum  
**RC** PPP Color - Upcharge

See PPP Color Card

### Specifications

- Adjustable shelves: 1/4" thick tempered glass, 3/8" thick non-tempered glass on 48" wide models.
- Glass shelves included: PMS-GL: 36" h - 2 48" h - 3 60" h - 3 72" h - 4  
PMS-B: 36" h - 1 48" h - 2 60" h - 2 72" h - 3
- Doors are on width side of showcase, unless otherwise specified. Door locks included.
- PMS-B models feature 12" h hardboard panel base available in any PPP Color.
- Bottom shelf finish: Black melamine. ±72" width models include 2 sets of doors, center frame and center shelf supports.
- Adjustable foot glides included.



# PepperMint® Freestanding Counters & Etageres

Model PMC-GL • All Glass      Model PMS-E-GL • All Glass  
 Model PMC-B • Panel Base      Model PMS-E • Open Display



PMC-GL



PMC-B

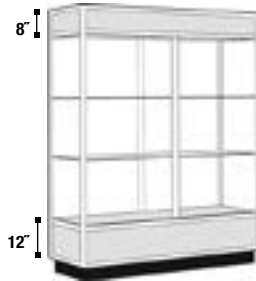

PMS-E-GL, 72" w  
 Illustrated with Optional Plinth

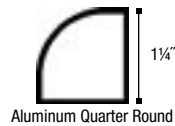

Aluminum Quarter Round

PMC-GL & PMC-B • Freestanding Counters		[GL]	[B]	Upcharge PPP Color Frame	NET Crafting Charge	Est. Ship Weight
Model	Size					
PMC[??]RA484220	48"w x 42"h x 20"d	\$6,990	\$6,030	\$699	\$459	275*
PMC[??]RA484224	48"w x 42"h x 24"d	\$7,451	\$6,408	\$745	\$475	309*
PMC[??]RA724224	±72"w x 42"h x 24"d	\$10,179	\$8,744	\$1,018	\$561	396*

± 72" width models include 2 sets of doors, center frame and center shelf supports.

**Options**  
 Lighting: See page 92.

Shipped by Truck\*

PMS-E & PMS-E-GL • Freestanding Etageres		[GL]	Upcharge PPP Color Frame	NET Crafting Charge	Est. Ship Weight	
Model	Size					
PMSE[??]RA488418	48"w x 84"h x 18"d gliding	\$6,970	\$10,199	\$697	\$566	406*
PMSE[??]RA488424	48"w x 84"h x 24"d gliding	\$7,714	\$11,133	\$772	\$600	491*
PMSE[??]RA608418	±60"w x 84"h x 18"d gliding	\$9,151	\$13,948	\$915	\$622	477*
PMSE[??]RA608424	±60"w x 84"h x 24"d gliding	\$10,092	\$15,051	\$1,009	\$657	557*
PMSE[??]RA728418	±72"w x 84"h x 18"d gliding	\$9,977	\$15,223	\$998	\$673	586*
PMSE[??]RA728424	±72"w x 84"h x 24"d gliding	\$11,047	\$16,461	\$1,105	\$707	623*

± 60" & 72" width models include center frame and center shelf supports.  
 ± 60" & 72" width GL models include 2 sets of gliding doors.

**Options**  
 Plinth: 2h, 4h or 6h. Black finish. See page 91.  
 Lighting: See page 92.  
 Lockable Accessible Storage on Model PMS-B \$388  
 Hardboard back panel - any PPP Color. Replaces Glass. \$201

Shipped by Truck\*

To Order Specify	
1. Quantity 2. Model: PMC-GL, PMC-B, PMS-E or PMS-E-GL 3. Frame Finish Code. Upcharge for PPP Color 4. Size: W x H x D 5. Panel Base: PPP Color (except Model PMC-GL) 6. <a href="#">Add NET Crating Charge</a> 7. <a href="#">Options</a>	<b>Finishes</b> RA Natural Anodized Aluminum RC PPP Color - Upcharge  See PPP Color Card

**Specifications**  
**PMC-GL & PMC-B:**

- PMC-GL models: Feature total glass enclosure, includes 2 shelves. Gliding lockable doors. Door locks included.
- PMC-B models: Glass display height of 26". Includes 1 shelf. Sliding lockable doors. Hardboard panel base with accessible locking storage and available in any PPP Color.
- Plinth: 4", black finish. Adjustable foot glides included.
- Tempered glass throughout with flush mounted top glass, 1/4" thick.
- Doors are on width side of showcase, unless otherwise specified. Door locks included.
- Adjustable shelves: 1/4" thick tempered glass, 3/8" thick non-tempered glass on 48" wide models.
- Bottom shelf finish: Black melamine.

**PMS-E & PMS-E-GL:**

- PMS-E features open frame display. No glass front, sides or back.
- PMS-E-GL features a glass enclosure with top and base panels. Doors are on width side of showcase, unless otherwise specified. Door locks included.
- Hardboard base panel 12h and top panel 8h available in any PPP Color.
- Top panel area can accommodate lighting. For lighting, See page 92.
- Adjustable shelves (3), 3/8" thick non-tempered glass.
- Bottom shelf finish: Black melamine.
- Adjustable foot glides included.



US  
 Shown with Traditional Top Detail and Optional Plinth

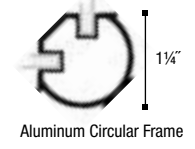

Aluminum Circular Frame

# PepperMint® Showcases

Model US • All Glass with Wood Tops

Model	Size	Door Type	# of Shelves	All Glass US	Upcharge PPP Color Frame	NET Crafting Charge	Est. Ship Weight
USA247224	24"w x 72"h x 24"d	1 hinged	4	\$5,743	\$574	\$453	278*
USA306024	30"w x 60"h x 24"d	2 hinged	3	\$6,676	\$667	\$453	272*
USA307224	30"w x 72"h x 24"d	2 hinged	4	\$7,547	\$755	\$486	320*
USA307230	30"w x 72"h x 30"d	2 hinged	4	\$8,110	\$811	\$510	367*
USA367218	36"w x 72"h x 18"d	2 hinged	4	\$7,434	\$743	\$483	307*
USA367224	36"w x 72"h x 24"d	2 hinged	4	\$8,063	\$806	\$514	362*
USA427218	42"w x 72"h x 18"d	2 hinged	4	\$7,889	\$789	\$510	345*
USA427224	42"w x 72"h x 24"d	2 hinged	4	\$8,581	\$858	\$541	402*

**Options**  
 Plinth: 2h, 4h or 6h. Black finish. See page 91.  
 Recessed lighting. Plinth required. Not available on (S) Spacer Top. See page 92.  
 Hardboard back panel - any PPP Color. Replaces Glass. \$201

Shipped by Truck\*

**Tops Available**



(S) Spacer Top  
 PPP Color Only

To Order Specify		
1. Quantity 2. Model: US 3. Frame Finish Code. Upcharge for PPP Color 4. Size: W x H x D 5. Top Finish: PPP Color Selection 6. <a href="#">Add NET Crating Charge</a> 7. <a href="#">Options</a>	<b>Finishes</b> A PPP Color CH Cherry LC Light Cherry HO Honey K Oak KS Medium Oak MA Natural Maple MM Mahogany LW Light Walnut W Walnut	<b>Frame Finishes</b> RA Natural Anodized Aluminum RC PPP Color - Upcharge

See PPP Color Card or Web

**Specifications**

- Hinged, locking door, 1/4" thick tempered glass with polished edge. Door locks included.
- Adjustable shelving: 1/4" thick tempered glass.
- Bottom shelf: Black finish.
- Adjustable foot glides included.



# PepperMint® Showcases

Model USZ • All Glass  
 Model USZ-B • Panel Base



# PepperMint® Showcases

Model ESZ • All Glass  
 Model ESZ-B • Panel Base

Model	Size	Door Type	# of Shelves		[Z]	[B]	Upcharge PPP Color Frame	NET Crafting Charge	Est. Ship Weight
			USZ	USB					
USZ[?]A247218	24"w x 72"h x 18"d	1 hinged	4	3	\$5,994	\$6,312	\$600	\$420	223*
USZ[?]A247224	24"w x 72"h x 24"d	1 hinged	4	3	\$6,501	\$6,801	\$650	\$453	264*
USZ[?]A307218	30"w x 72"h x 18"d	2 hinged	4	3	\$7,662	\$7,956	\$766	\$453	259*
USZ[?]A307224	30"w x 72"h x 24"d	2 hinged	4	3	\$8,222	\$8,487	\$822	\$486	305*
USZ[?]A367218	36"w x 72"h x 18"d	2 hinged	4	3	\$8,113	\$8,402	\$811	\$483	294*
USZ[?]A367224	36"w x 72"h x 24"d	2 hinged	4	3	\$8,728	\$8,979	\$873	\$514	344*
USZ[?]A427218	42"w x 72"h x 18"d	2 hinged	4	3	\$8,576	\$8,849	\$858	\$510	329*
USZ[?]A427224	42"w x 72"h x 24"d	2 hinged	4	3	\$9,241	\$9,467	\$924	\$541	385*

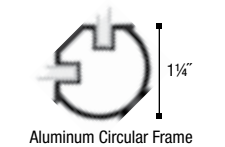
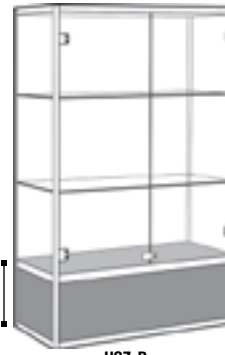

### Options

Plinth: 2'h, 4'h or 6'h. Black finish. *See page 91.*  
 Linear and recessed lighting. Requires 4'h or 6'h Plinth. *See page 92.*  
 Lockable Accessible Storage on Model PMS-B

Lockable Accessible Storage on Model PMS-B	\$388
Hardboard back panel - any PPP Color. Replaces Glass.	\$201

Shipped by Truck\*

### Top Detail



Aluminum (Z)

### To Order Specify

- Quantity
- Model: USZ or USZ-B
- Frame Finish Code. Upcharge for PPP Color
- Size: W x H x D
- Panel Base: USZ-B only: PPP Color
- Add NET Crating Charge**
- Options**

**Frame Finishes**  
**RA** Natural Anodized Aluminum  
**RC** PPP Color - Upcharge

*See PPP Color Card or Web*

### Specifications

- USZ model includes top and bottom door locks.
- Hinged, locking doors, 1/4" thick tempered glass with polished edges. Door locks included.
- Adjustable shelves: 1/4" thick tempered glass.
- USZ-B models feature 12" hardboard panel base available in any PPP Color.
- Bottom shelf finish: Black melamine.
- Adjustable foot glides included.

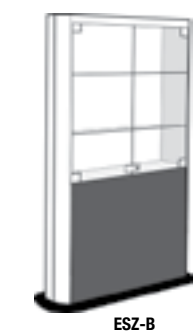

### Top Details

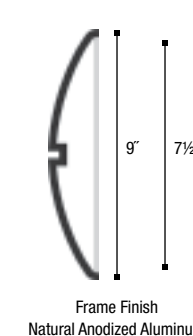

© 11/2024

© 11/2024

Model	Size	Door Type	# of Shelves		All Glass	Panel Base [B]	NET Crafting Charge	Est. Ship Weight
			ESZ	ESB				
ESZ[?]A32609	32"w x 60"h x 9"d	2 hinged	3	2	\$5,801	\$5,167	\$410	207*
ESZ[?]A32729	32"w x 72"h x 9"d	2 hinged	4	3	\$6,420	\$6,172	\$448	241*
ESZ[?]A36609	36"w x 60"h x 9"d	2 hinged	3	2	\$6,036	\$5,375	\$424	225*
ESZ[?]A36729	36"w x 72"h x 9"d	2 hinged	4	3	\$6,692	\$6,419	\$448	262*
ESZ[?]A42609	42"w x 60"h x 9"d	2 hinged	3	2	\$6,380	\$5,801	\$453	253*
ESZ[?]A42729	42"w x 72"h x 9"d	2 hinged	4	3	\$7,088	\$6,778	\$486	295*

### Options

Recessed Lighting available on ESZ & ESZ-B models. *See page 91-98.*

Upcharge PPP Color frame	15%
Hardboard back panel - any PPP Color. Replaces Glass.	\$201

\*30" panel base models include one less shelf

Shipped by Truck\*

### To Order Specify

- Quantity
- Model: ESZ, ESZ-B
- Size: W x H x D
- Panel Base Finish: Model ESZ-B only
- Add NET Crating Charge**
- Options**

### Finishes

<b>A</b> PPP Color	<b>MA</b> Natural Maple
<b>CH</b> Cherry	<b>MM</b> Mahogany
<b>LC</b> Light Cherry	<b>LW</b> Light Walnut
<b>HO</b> Honey	<b>W</b> Walnut

*See PPP Color Card or Web*

### Specifications

- Hinged locking doors, 1/4" tempered glass with polished edges. Door locks included.
- ESZ models include top and bottom door locks.
- ESZ-B models feature 30" panel base, available in melamine wood finish or any PPP Color.
- Adjustable shelves in 2" increments, 1/4" thick tempered glass.
- Interior Depth: 7 3/4". Interior sides and bottom finish: Cool Grey melamine.
- Base: Black finish. Depth: 16". Width: width of case plus 5". Adjustable foot glides included.





# PepperMint® Wall Mounted Showcases

Model ESW-Z

Model ESW-S with Lighting Soffit



ESW-Z



ESW-S

With Recessed Lighting

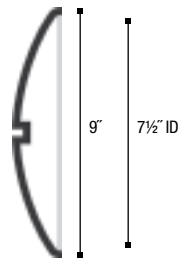

Side Frame Finish  
Natural Anodized Aluminum

Model	Size	Door Type	# of Shelves	# of Lights (ESWS Only)	[Z]	Lighting Included [S]	NET Crafting Charge	Est. Ship Weight
ESW[?]A24369	36"w x 24"h x 9"d	sliding	1	2	\$2,476	\$3,277	\$254	87*
ESW[?]A36369	36"w x 36"h x 9"d	sliding	2	2	\$3,123	\$3,926	\$337	121*
ESW[?]A42369	36"w x 42"h x 9"d	sliding	3	2	\$3,518	\$4,317	\$352	141*
ESW[?]A36489	48"w x 36"h x 9"d	sliding	2	3	\$3,958	\$4,973	\$383	157*
ESW[?]A42489	48"w x 42"h x 9"d	sliding	3	3	\$4,590	\$5,606	\$396	183*

### Options

Recessed Lighting for Model ESW-S. See page 92.

Upcharge PPP Color frame ..... 15%

Shipped by Truck\*

### Top Details



ESW-Z

### Soffit Details



ESW-S

### To Order Specify

- Quantity
- Model: ESW-Z or ESW-S
- Size: W x H x D
- ESW-S Soffit: PPP Color
- Back Panel: PPP Color
- [Add NET Crating Charge](#)
- Options

### Specifications

- Model ESW-S features 6" lighting soffit. Includes recessed low voltage lighting. Soffit panel insert available in any PPP Color.
- Sliding locking doors, 5/32" tempered glass with polished edges. Door locks included.
- Adjustable shelving in 2" increments: 1/4" thick tempered glass, 3/8" thick non-tempered glass on 48" models.
- Hardboard back panel in any PPP Color.
- Interior sides and bottom shelf finish: Cool Grey melamine. ESW-Z and ESW-S Top, 1/8" Cool Grey MDF.
- Wall mounting cleat/bracket and hardware included.

# PepperMint® & MiniMint®

Wall Mounted Showcases

Models PMW & PMW-S with 4" Lighting Soffit

Models MMW & MMW-S with 4" Lighting Soffit



PMW



PMW-S

with 4" Lighting Soffit  
Illustrated with optional recessed lighting.

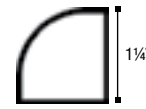

PMW Frame Quarter Round



MMW



MMW-S

with 4" Lighting Soffit  
Illustrated with optional recessed lighting.

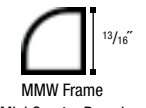

MMW Frame Mini Quarter Round

PepperMint PMW & PMW-S				All Glass	Soffit [S]	Upcharge PPP Color Frame	NET Crafting Charge	Est. Ship Weight
Model	Size	Door Type	# of Shelves					
PMW[?]RA423612	42"w x 36"h x 12"d	sliding	2	\$4,036	\$4,774	\$404	\$374	157*
PMW[?]RA42429	42"w x 42"h x 9"d	sliding	2	\$4,245	\$4,965	\$424	\$374	152*
PMW[?]RA424212	42"w x 42"h x 12"d	sliding	2	\$4,516	\$5,255	\$452	\$391	180*
PMW[?]RA48429	48"w x 42"h x 9"d	sliding	3	\$5,006	\$5,770	\$501	\$396	187*
PMW[?]RA484212	48"w x 42"h x 12"d	sliding	3	\$5,425	\$6,200	\$542	\$415	218*

### Options

Models PMW-S & MMW-S features 4" lighting soffit. For optional lighting systems, See page 92.

Shipped by Truck\*

MiniMint MMW & MMW-S				All Glass	Soffit [S]	Upcharge PPP Color Frame	NET Crafting Charge	Est. Ship Weight
Model	Size	Door Type	# of Shelves					
MMW?RA30367	30"w x 36"h x 7"d	sliding	3	\$3,277	\$3,880	\$327	\$265	91*
MMW?RA36307	36"w x 30"h x 7"d	sliding	2	\$3,154	\$3,784	\$315	\$265	90*
MMW?RA36367	36"w x 36"h x 7"d	sliding	3	\$3,538	\$4,165	\$354	\$287	106*

### Options

Models PMW-S & MMW-S features 4" lighting soffit. For optional lighting systems, See page 92.

Shipped by Truck\*

### To Order Specify

- Quantity
- Model: PMW, PMW-S, MMW or MMW-S
- Frame Finish Code. Upcharge for PPP Color
- Size: W x H x D
- Back Panel and/or Soffit: PPP Color
- [Add NET Crating Charge](#)
- Options

### Frame Finishes

- RA** Natural Anodized Aluminum
- RC** PPP Color - Upcharge

See PPP Color Card or Web

### Specifications

- Models PMW-S and MMW-S feature 4" soffit. Soffit panel insert in any PPP Color.
- Hardboard back panel: any PPP Color.
- Adjustable shelving: 1/4" thick tempered glass, 3/8" thick non-tempered glass on 48" models.
- Sliding locking doors, 5/32" tempered glass with polished edges. Door locks included.
- Bottom shelf finish: Black melamine.
- Wall mounting cleat/bracket and hardware included.
- For recessed wall mounted showcases, please submit your requirements.



© 9/2022 © 11/2024

© 11/2024



## Section 10

### VISUAL COMMUNICATION

#### COLLECTION

Tactics® & Tactics Plus® Writing Surfaces  
Porcelain & Glass

Tackable Panels

Combination Bulletin/Tack Boards

Message Centers

PepperMint® & MiniMint®

#### PRICE LIST & SPECIFICATIONS

Effective January 1, 2026

All Prices are Suggested List Price

Updated 11.03.25

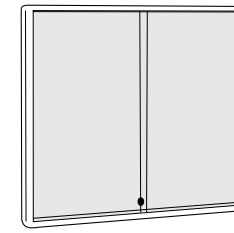

MMD-2

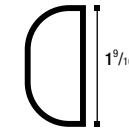

MMD-2  
Semi-Circular Frame

## MiniMint® Wall Mounted Bulletin/Tack Boards

Model MMD-2 • Glass Enclosed

For larger sizes of MMD-2, see MM-CW-GL on the following pages

Model	Size	Natural Cork	ColorCork	Fabric or COM	Upcharge PPP Color Frame	NET Crafting Charge	Est. Ship Weight
MMDRA242402	24"w x 24"h	\$1,551	\$2,204	\$1,695	\$155	\$143	36*
MMDRA243002	24"w x 30"h	\$1,691	\$2,403	\$1,847	\$169	\$162	44*
MMDRA243602	24"w x 36"h	\$1,833	\$2,621	\$2,010	\$183	\$172	52*
MMDRA362402	36"w x 24"h	\$1,833	\$2,621	\$2,010	\$183	\$172	52*
MMDRA363002	36"w x 30"h	\$2,031	\$2,889	\$2,220	\$203	\$193	64*
MMDRA363602	36"w x 36"h	\$2,209	\$3,143	\$2,420	\$221	\$211	75*
MMDRA364802	36"w x 48"h	\$2,572	\$3,664	\$2,812	\$257	\$237	98*
MMDRA482402	48"w x 24"h	\$2,160	\$3,076	\$2,365	\$216	\$202	68*
MMDRA483002	48"w x 30"h	\$2,379	\$3,387	\$2,603	\$238	\$218	83*
MMDRA483602	48"w x 36"h	\$2,572	\$3,664	\$2,812	\$257	\$240	98*
MMDRA484202	48"w x 42"h	\$2,818	\$3,998	\$3,078	\$282	\$263	113
MMDRA484802	48"w x 48"h	\$3,027	\$4,306	\$3,315	\$303	\$277	128*

Shipped by Truck\*

#### To Order Specify

- Quantity
- Model
- Frame Finish Code. Upcharge for PPP Color
- Size: W x H
- Panel: Natural Cork  
ColorCork  
Fabric Selection  
COM (Customer's Own Material)
- Add NET Crating Charge

**Frame Finishes**  
**RA** Natural Anodized Aluminum  
**RC** PPP Color - Upcharge  
**ColorCork**  
 2186  
 2187  
 2209

**Fabric Selection - see page 115**  
 Guilford of Maine  
 Sprite Style 2671  
 Lido Style 2858  
 Crosstown Style 2526  
 COM: Customer's Own Material  
 Page 121 for shipping information

See PPP Color Card or Web

#### Specifications

- MMD-2: OD: 2", ID: 7/16"
- Sliding, lockable, tempered glass doors. Door locks included. For polycarbonate sliding doors, add 15% upcharge.
- Back panel in Natural Cork, ColorCork, Fabric or COM tackable panel. For ColorCork specifications, see page 115.
- Wall mounting cleat/bracket and hardware included.

© 11/2024

© 11/2024



OSHPD Seismic Compliant  
Anchorage in California



# MiniMint® Wall Mounted Combination Units

- Model MM-CW • Open Frame  
 Model MM-CW-GL • Glass Enclosed

# MiniMint® Wall Mounted Combination Units

- Model MM-CW • Open Frame  
 Model MM-CW-GL • Glass Enclosed

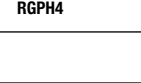
Model	Size	# of Panels	Standard Natural Cork		Optional Add for Each Panel			Upcharge PPP Color Frame	MM-CW-GL Only NET Crafting Charge	Est. Ship Weight	Size	# of Panels	Door Type	Panel Configurations		
			Open Frame	Glass Enclosed [GL]	Writing Surface	Fabric or COM	ColorCork							Panel Group 1 Panel Widths 2 Panels	Panel Group 3 Panel Widths 3 Panels	Panel Group 4 Panel Widths 3 Panels
MMCW[??]RA3636	36"w x 36"h	2	\$1,739	\$2,730	\$252	\$183	\$238	\$174	\$211	64*	36"w x 36"h	2	1 set sliding	18 • 18		
MMCW[??]RA4836	48"w x 36"h	2	\$1,945	\$3,040	\$272	\$192	\$257	\$194	\$250	83*	48"w x 36"h	2	1 set sliding	24 • 24		
MMCW[??]RA4848	48"w x 48"h	2	\$2,225	\$3,502	\$313	\$232	\$295	\$223	\$277	107*	48"w x 48"h	2	1 set sliding	24 • 24		
MMCW[??]RA6036	60"w x 36"h	2	\$2,143	\$3,401	\$289	\$211	\$272	\$214	\$273	104*	60"w x 36"h	2	1 set sliding	30 • 30		
MMCW[??]RA6048	60"w x 48"h	2	\$2,760	\$3,853	\$313	\$228	\$295	\$276	\$310	134*	60"w x 48"h	2	1 set sliding	30 • 30		
MMCW[??]RA7236	72"w x 36"h	2	\$2,455	\$4,364	\$366	\$267	\$345	\$246	\$297	127*	72"w x 36"h	2	2 sets sliding	36 • 36		
MMCW[??]RA7248	72"w x 48"h	2	\$2,811	\$5,294	\$420	\$309	\$396	\$281	\$337	163*	72"w x 48"h	2	2 sets sliding	36 • 36		
MMCW[??]RA9648	96"w x 48"h	3	\$3,581	\$6,719	\$459	\$332	\$432	\$358	\$392	212*	96"w x 48"h	3	3 sets sliding		24 • 48 • 24	32 • 32 • 32
5790	12 Dry Erase Markers, Eraser, Board Cleaner							\$142	2							
 RGPH2	Marker and eraser holder. Holds 2 markers and 1 eraser. Accessories not included. Double sided tape included.					7"w x 2 3/4"h x 2"d	\$39									
 RGPH4	Marker and eraser holder. Holds 4 markers and 1 eraser. Accessories not included. Double sided tape included.					10"w x 2 3/4"h x 2"d	\$55									
Shipped by Truck*																

To Order Specify		
<ol style="list-style-type: none"> <li>Quantity</li> <li>Model</li> <li>Frame Finish Code. Upcharge for PPP Color</li> <li>Size: W x H</li> <li>Panel Group: 1, 3 or 4 Note: List Panel Widths &amp; Type, Left-to-Right (See ordering examples, opposite page)</li> <li><b>Standard Panel:</b> Natural Cork</li> <li><b>Optional Panels:</b> Writing Surface - White, ColorCork, Fabric Selection or COM</li> <li><b>Add NET Crating Charge</b> MM-CW-GL only</li> <li><b>Options</b></li> </ol>	<p><b>Frame Finishes</b></p> <p><b>RA</b> Natural Anodized Aluminum  <b>RC</b> PPP Color - Upcharge</p> <p><b>ColorCork</b></p> <p>2186                  2187                  2209</p>	<p><b>Fabric Selection - see page 115</b></p> <p>Guilford of Maine                  Sprite Style 2671                  Lido Style 2858                  Crosstown Style 2526                  COM: Customer's Own Material                  Page 121 for shipping information</p>
See PPP Color Card or Web		

- Specifications**
- MM-CW:** Quarter round mini-profile, open frame.
  - MM-CW-GL:** Semi-circular mini profile frame with sliding, lockable, tempered glass doors. Door locks included. For polycarbonate sliding doors, add 15% upcharge.
  - Any combination of Standard or Optional Panels may be ordered.
- Standard Panel**
- Natural Cork
- Optional Panels with Upcharge**
- Writing Surface Panels:** White. Porcelain enamel writing surface fused to 28 gauge steel. Full width pen rail, 4 dry erase markers and eraser included.
  - ColorCork:** For specifications, see page 115.
  - Fabric** covered tackboard.
  - COM:** Tackboard covered in Customer's Own Material. For COM instructions, see page 115.
  - Wall mounting cleat/bracket and hardware included.

### Ordering Example for Panel Configurations

MM-CW (Open Frame)  
 96" w x 48" h Panel Group 3 3 Panels

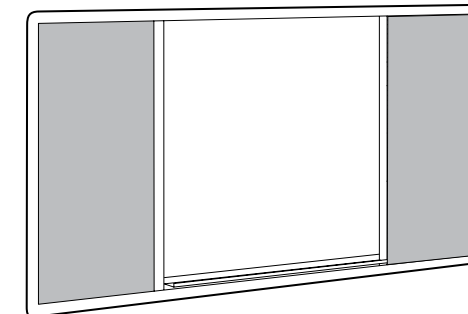

Writing Surface Panel with Pen Rail Illustrated

- Left Panel - 24" Cork
- Center Panel - 48" Writing Surface Panel
- Right Panel - 24" Cork

Specify panel widths and type, left-to-right

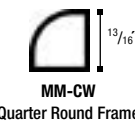

MM-CW  
Quarter Round Frame

MM-CW-GL (Glass Enclosed)  
 72" w x 36" h Panel Group 1 2 Panels with 2 sets of sliding glass doors

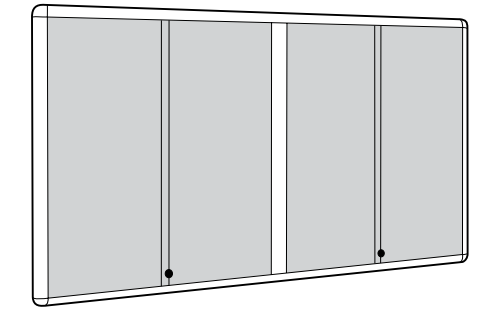

- Left Panel - 36" Fabric Panel
- Right Panel - 36" Fabric Panel

Specify panel widths and type, left-to-right



MM-CW-GL  
Semi-Circular Frame



# Wood Framed, Wall Mounted Bulletin/Tackboards

Model WB-CW-GL Combination Panels • Glass Enclosed



WB-CW-GL  
ID: 1 1/16" on all models

Model	Size	Sliding Door Sets	Natural Cork	ColorCork	Fabric or COM	NET Crafting Charge	Est. Ship Weight
WBCWGL3624	36"w x 24"h	1	\$1,992	\$2,319	\$2,193	\$162	45*
WBCWGL3636	36"w x 36"h	1	\$2,058	\$2,592	\$2,266	\$198	64*
WBCWGL4836	48"w x 36"h	1	\$2,566	\$3,336	\$2,819	\$227	83*
WBCWGL4848	48"w x 48"h	1	\$2,643	\$3,432	\$2,905	\$261	107*
WBCWGL6036	60"w x 36"h	1	\$2,739	\$3,560	\$3,011	\$258	104*
WBCWGL6048	60"w x 48"h	1	\$2,907	\$3,777	\$3,195	\$292	134*
WBCWGL7236	72"w x 36"h	2	\$3,291	\$4,278	\$3,620	\$280	127*
WBCWGL7248	72"w x 48"h	2	\$3,993	\$5,195	\$4,395	\$319	163*
WBCWGL8436	84"w x 36"h	2	\$4,159	\$5,407	\$4,580	\$301	145*
WBCWGL8448	84"w x 48"h	2	\$4,776	\$6,207	\$5,251	\$345	187*
WBCWGL9636	96"w x 36"h	2	\$4,416	\$5,739	\$4,855	\$323	164*
WBCWGL9648	96"w x 48"h	2	\$5,072	\$6,593	\$5,581	\$370	212*

For combination panels, use highest Panel Price column.

Shipped by Truck\*

### Wood Frame Styles

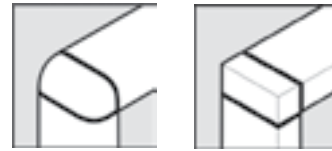

(R) Radius

(L) Linear

### To Order Specify

1. Quantity	<b>Frame Finishes</b>	<b>ColorCork</b>	<b>Fabric Selection - see page 115</b>
2. Model: WB-CW-GL	<b>CH</b> Cherry	2186	Guilford of Maine
3. Size: W x H	<b>LC</b> Light Cherry	2187	Sprite Style 2671
4. Frame Style: R (Radius) or L (Linear)	<b>HO</b> Honey	2209	Lido Style 2858
5. Frame: Wood Finish	<b>MA</b> Natural Maple		Crosstown Style 2526
6. Panel: Natural Cork ColorCork Fabric Selection COM (Customer's Own Material)	<b>MM</b> Mahogany		COM: Customer's Own Material Page 121 for shipping information
7. Add NET Crating Charge	<b>LW</b> Light Walnut		
	<b>W</b> Walnut		

See PPP Color Card or Web

### Specifications

- WB-CW-GL Frame styles: R (Radius) or L (Linear). OD 2 1/2". ID 1 1/16".
- Single or Combination Panels: Any combination of panels in equal widths may be ordered. For combination panels, use highest Panel Price column.
- Back panel in Natural Cork, ColorCork, Fabric or COM tackable panel.  
For ColorCork specifications, see page 115.
- Sliding, lockable, tempered glass doors. Door locks included. For polycarbonate sliding doors, add 15% upcharge.
- Wall mounting cleat/bracket and hardware included.

# Magnetic Glass Writing Surface

Model GB • Non-Magnetic

Model GBX • Magnetic

Concealed or Standoff Mount

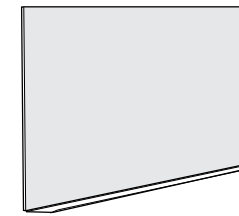

Concealed Mount  
Full width pen rail

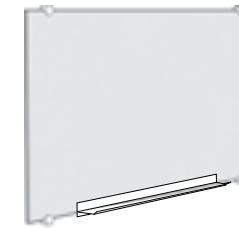

Standoff Mount  
Pen rail 12" less than full width

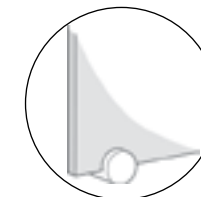

Standoff Detail



GB-MAG



5790

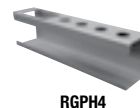

RGP4

Model	Size	Description	Model GBX Magnetic Glass	Upcharge Standoff Mount	Est. Ship Weight
GBX2436	24"w x 36"h	Magnetic Glass Writing Surface		\$620	30^
GBX3624	36"w x 24"h	Magnetic Glass Writing Surface		\$620	30^
GBX3648	36"w x 48"h	Magnetic Glass Writing Surface		\$840	63*
GBX4836	48"w x 36"h	Magnetic Glass Writing Surface		\$840	63*
GBX7248	72"w x 48"h	Magnetic Glass Writing Surface		\$1,202	121*
GBX9648	96"w x 48"h	Magnetic Glass Writing Surface		\$1,428	161*

### Options

5790	12 Dry Erase Markers, Eraser, Board Cleaner		\$142	2
RGP4	Marker and eraser holder. Holds 2 markers and 1 eraser. Accessories not included. Double sided tape included.	7"w x 2 3/4"h x 2"d	\$39	
RGP4	Marker and eraser holder. Holds 4 markers and 1 eraser. Accessories not included. Double sided tape included.	10"w x 2 3/4"h x 2"d	\$55	

^UPS Dimensional Weight Shipped by Truck\*

### To Order Specify

- |               |                            |
|---------------|----------------------------|
| 1. Quantity   | <b>Mount Type</b>          |
| 2. Model      | Concealed                  |
| 3. Size       | Standoff – <b>Upcharge</b> |
| 4. Mount Type |                            |
| 5. Options    |                            |

### Specifications

- Model GBX: Starphire® tempered magnetic glass surface, back coated white, 1/4" thick with flat polished edges. Low iron content produces clear edges and crystal-clear appearance.
- Corners have a 1/4" radius with pencil polished edges.
- Concealed Mount: Wall cleat/bracket and hardware included.
- Magnetic Boards include 5 Rare Earth Magnets.
- Standoff Mount: 1" dia. x 1 1/4" d aluminum standoffs mount to wall. Glass is inserted into notch and tightened with set-screw. Aluminum disc conceals fasteners. Upcharge  
**24" - 48" wide** 4 Standoffs Included  
**72" wide** 6 Standoffs Included  
**96" wide** 8 Standoffs Included
- Pen Rail: Natural Anodized Aluminum extrusion mounts to lower edge of glass marker board. Includes 4 dry erase markers and eraser. Concealed Mount surfaces include a full length pen rail. Stand-Off Mount includes a pen rail measuring 12" less than full width of the writing surface.
- Model GBX boards do not comply with the Trade Agreements Act (TAA) and are not available for GSA contract purchases.

Portions of this product line previously listed in the catalog are temporarily unavailable. Please contact customerservice@peterpepper.com to explore alternatives.



# MiniMint® Writing Surface

## Model MM-LMB



MM-LMB  
Open Frame, 1" Depth

Custom silk screen graphics are available on writing surface. Please submit your requirements.



5790

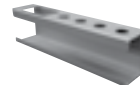

RGPH4



Mini-Aluminum  
Quarter Round

MiniMint® Writing Surface - Model MM-LMB			List	Upcharge PPP Color Frame	Est. Ship Weight
Model	Size	Description			
MMLMBRA24241	24"w x 24"h	Writing Surface	\$1,201	\$120	22^
MMLMBRA36241	36"w x 24"h	Writing Surface	\$1,385	\$139	28^
MMLMBRA36361	36"w x 36"h	Writing Surface	\$1,653	\$165	35^
MMLMBRA48361	48"w x 36"h	Writing Surface	\$1,954	\$195	46*
MMLMBRA60481	60"w x 48"h	Writing Surface	\$2,940	\$294	67*
MMLMBRA72361	72"w x 36"h	Writing Surface	\$2,679	\$267	63*
MMLMBRA72481	72"w x 48"h	Writing Surface	\$3,083	\$309	78*
MMLMBRA96481	96"w x 48"h	Writing Surface	\$3,756	\$376	101*

### Options

5790	12 Dry Erase Markers, Eraser, Board Cleaner		\$142	2
RGPH2	Marker and eraser holder. Holds 2 markers and 1 eraser. Accessories not included. Double sided tape included.	7"w x 2 3/4"h x 2"d	\$39	
RGPH4	Marker and eraser holder. Holds 4 markers and 1 eraser. Accessories not included. Double sided tape included.	10"w x 2 3/4"h x 2"d	\$55	
			^UPS Dimensional Weight	Shipped by Truck*

To Order Specify	
1. Quantity	<b>Frame Finishes</b> <b>RA</b> Natural Anodized Aluminum <b>RC</b> PPP Color - Upcharge  <i>See PPP Color Card</i>
2. Model	
3. Frame Finish Code. Upcharge for PPP Color	
4. Size: W x H	
5. Options	

### Specifications

- White porcelain enamel writing surface fused to 28 gauge steel. Writing surface accepts magnetic accessories.
- Includes full length pen rail, 4 dry erase markers and eraser. Natural Anodized Aluminum.
- Wall mounting cleat/bracket and hardware included.



# TACTICS PLUS®

## Writing Surface Wall Mounted



WS7248  
Custom silk screen graphics are available on writing surface. Please submit your requirements.



WS4836  
Corner Detail

Model	Description	Size	White Porcelain	Est. Ship Weight
WS2430	Writing Surface	24"w x 30"h x 3/4"d	\$529	19^
WS2436	Writing Surface	24"w x 36"h x 3/4"d	\$539	22^
WS3036	Writing Surface	30"w x 36"h x 3/4"d	\$616	27^
WS3624	Writing Surface	36"w x 24"h x 3/4"d	\$539	22^
WS3636	Writing Surface	36"w x 36"h x 3/4"d	\$690	31^
WS4824	Writing Surface	48"w x 24"h x 3/4"d	\$630	31*
WS4836	Writing Surface	48"w x 36"h x 3/4"d	\$785	41
WS4848	Writing Surface	48"w x 48"h x 3/4"d	\$949	53*
WS6048	Writing Surface	60"w x 48"h x 3/4"d	\$1,111	68*
WS7248	Writing Surface	72"w x 48"h x 3/4"d	\$1,301	78*
WS9648	Writing Surface	96"w x 48"h x 3/4"d	\$1,526	103*
WS12048	Writing Surface	120"w x 48"h x 3/4"d	\$2,179	134*

^UPS Dimensional Weight  
Shipped by Truck\*  
Board sizes are nominal. Contact factory for exact sizes/profile.

To Order Specify	
1. Quantity	
2. Model	

### Specifications

- Aluminum frames finished in Natural Anodized Aluminum.
- White porcelain enamel writing surface fused to 28 gauge steel. Writing surface accepts magnetic accessories.
- Includes 12" Aluminum pen rail, 4 dry erase markers and eraser.
- Wall mounting cleat/bracket and hardware included.

© 11/2024

© 11/2024





**TACTICS PLUS®**  
**Fabric Tackable Panel &**  
**Combination Board - Tackable & Writing Surface**  
**Wall Mounted**

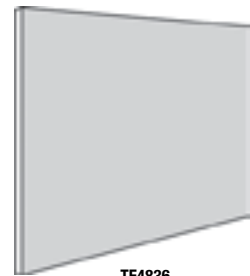

TF4836



Corner Detail



CB3636

Custom silk screen graphics are available on writing surface. Please submit your requirements.

Fabric Tackable Panel			Fabric Covered Panels	Est. Ship Weight
Model	Description	Size		
TF1824	Fabric Tackable Panel	18"w x24"h x 3/4"d	\$431	7
TF2418	Fabric Tackable Panel	24"w x18"h x 3/4"d	\$431	7
TF2424	Fabric Tackable Panel	24"w x24"h x 3/4"d	\$441	9^
TF2436	Fabric Tackable Panel	24"w x36"h x 3/4"d	\$508	11^
TF3624	Fabric Tackable Panel	36"w x24"h x 3/4"d	\$508	11^
TF3636	Fabric Tackable Panel	36"w x36"h x 3/4"d	\$652	15^
TF4824	Fabric Tackable Panel	48"w x24"h x 3/4"d	\$594	20*
TF4836	Fabric Tackable Panel	48"w x36"h x 3/4"d	\$741	26*
TF4848	Fabric Tackable Panel	48"w x48"h x 3/4"d	\$895	31*
TF7248	Fabric Tackable Panel	72"w x48"h x 3/4"d	\$1,227	66*
TF9648	Fabric Tackable Panel	96"w x48"h x 3/4"d	\$1,440	89*

Combination Board				Natural Cork w/ White Porcelain	Fabric Covered Panels	Est. Ship Weight
Model	Description	Size	Panel Widths L/R			
CB3030	Combination Board	30"w x 30"h x 3/4"d	15/15	\$817	\$896	19^
CB3624	Combination Board	36"w x 24"h x 3/4"d	18/18	\$793	\$872	17^
CB3630	Combination Board	36"w x 30"h x 3/4"d	18/18	\$857	\$936	21^
CB3636	Combination Board	36"w x 36"h x 3/4"d	18/18	\$918	\$998	24^
CB4824	Combination Board	48"w x 24"h x 3/4"d	24/24	\$894	\$1,010	24*
CB4830	Combination Board	48"w x 30"h x 3/4"d	24/24	\$944	\$1,060	28*
CB4836	Combination Board	48"w x 36"h x 3/4"d	24/24	\$986	\$1,103	31*
CB4848	Combination Board	48"w x 48"h x 3/4"d	24/24	\$1,226	\$1,381	40*
CB7248	Combination Board	72"w x 48"h x 3/4"d	36/36	\$1,717	\$1,953	59*
CB9648	Combination Board	96"w x 48"h x 3/4"d	36/36	\$2,126	\$2,418	77*

^ UPS Dimensional Weight Shipped by Truck\*  
 Board sizes are nominal. Contact factory for exact sizes/profile.

**To Order Specify**

- Quantity
- Model
- TF Models: Fabric Selection
- CB Models: Tackable Panel: Natural Cork, Fabric or COM - Fabric or COM Upcharge

**Fabric Selection - see page 115**  
 Guilford of Maine  
 Sprite Style 2671  
 Lido Style 2858  
 Crosstown Style 2526  
 COM: Customer's Own Material  
 Page 121 for shipping information  
 See PPP Color Card or Web

**Specifications**

- Wall mounting cleat/bracket and hardware included.
- Aluminum frame finished in Natural Anodized Aluminum.

**TF Models:**

- Fabric or COM laminated to lightweight tackable core.

**CB Models:**

- Porcelain enamel writing surface fused to 28 gauge steel. Writing surface accepts magnetic accessories.
- Includes 12" Aluminum pen rail, 4 dry erase markers and eraser.
- Combination Boards have natural cork or fabric tackable panel on left side.

For accessories, see pages 118 & 119.



**TACTICS®**  
**Communication Boards**  
**Writing Surface • Fabric • Natural Cork**



**Writing Surface**  
 Custom silk screen graphics are available on writing surface. Please submit your requirements.



Fabric Tackable or COM Panel

Model	Description	Size	Profiles 5, 7		Profiles 8, 9	
			List	Est. Ship Weight	List	Est. Ship Weight
TC2436	Writing Surface	24"w x 36"h	\$616	22^	\$709	25^
TC3624	Writing Surface	36"w x 24"h	\$616	22^	\$709	25^
TC3636	Writing Surface	36"w x 36"h	\$790	31^	\$914	33^
TC3648	Writing Surface	36"w x 48"h	\$878	41*	\$1,011	43*
TC4836	Writing Surface	48"w x 36"h	\$878	41*	\$1,011	43*
TC4848	Writing Surface	48"w x 48"h	\$1,036	53*	\$1,188	55*
TC6036	Writing Surface	60"w x 36"h	\$1,163	53*	\$1,289	50*
TC6048	Writing Surface	60"w x 48"h	\$1,332	69*	\$1,514	66*
TC7236	Writing Surface	72"w x 36"h	\$1,281	64*	\$1,473	67*
TC7248	Writing Surface	72"w x 48"h	\$1,415	92*	\$1,624	94*
TC9648	Writing Surface	96"w x 48"h	\$1,749	114*	\$2,012	121*
TC12048	Writing Surface	120"w x 48"h	\$2,610	157*	\$3,001	160*
TC14448	Writing Surface	144"w x 48"h	\$3,386	205*	\$3,896	210*
FB2436	Tackable Fabric Panel	24"w x 36"h	\$581	14^	\$669	16^
FB3624	Tackable Fabric Panel	36"w x 24"h	\$581	14^	\$669	16^
FB3636	Tackable Fabric Panel	36"w x 36"h	\$745	16^	\$862	17^
FB3648	Tackable Fabric Panel	36"w x 48"h	\$828	20*	\$954	22*
FB4836	Tackable Fabric Panel	48"w x 36"h	\$828	20*	\$954	22*
FB4848	Tackable Fabric Panel	48"w x 48"h	\$978	26*	\$1,121	28*
FB6036	Tackable Fabric Panel	60"w x 36"h	\$1,111	27*	\$1,337	30*
FB6048	Tackable Fabric Panel	60"w x 48"h	\$1,273	34*	\$1,450	36*
FB7236	Tackable Fabric Panel	72"w x 36"h	\$1,208	36*	\$1,389	38*
FB7248	Tackable Fabric Panel	72"w x 48"h	\$1,334	50*	\$1,532	62*
FB9648	Tackable Fabric Panel	96"w x 48"h	\$1,649	72*	\$1,899	76*

^UPS Dimensional Weight Shipped by Truck\*  
 All board sizes are nominal. Contact factory for exact sizes/profile.

**Specifications & Ordering Information (See page 115. For Accessories, see page 113.)**





**TACTICS®**  
**Communication Boards**  
 Writing Surface • Fabric • Natural Cork



Natural Cork Tackable Panel

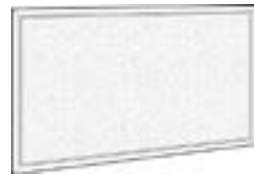

ColorCork Selection  
See Web

Model	Description	Size	Profiles 5, 7		Profiles 8, 9	
			List	Est. Ship Weight	List	Est. Ship Weight
CK2436	Natural Cork Tackable Panel	24"w x 36"h	\$458	11^	\$529	13^
CK3624	Natural Cork Tackable Panel	36"w x 24"h	\$458	11^	\$529	13^
CK3636	Natural Cork Tackable Panel	36"w x 36"h	\$564	20^	\$653	21^
CK3648	Natural Cork Tackable Panel	36"w x 48"h	\$675	22*	\$777	21*
CK4836	Natural Cork Tackable Panel	48"w x 36"h	\$675	24*	\$777	26*
CK4848	Natural Cork Tackable Panel	48"w x 48"h	\$828	29*	\$954	31*
CK6036	Natural Cork Tackable Panel	60"w x 36"h	\$942	37*	\$956	39*
CK6048	Natural Cork Tackable Panel	60"w x 48"h	\$1,096	41*	\$1,166	43*
CK7236	Natural Cork Tackable Panel	72"w x 36"h	\$957	45*	\$1,107	48*
CK7248	Natural Cork Tackable Panel	72"w x 48"h	\$1,130	51*	\$1,298	53*
CK9648	Natural Cork Tackable Panel	96"w x 48"h	\$1,419	74*	\$1,637	77*
PB2436	ColorCork Tackable Panel	24"w x 36"h	\$502	18^	\$738	19^
PB3624	ColorCork Tackable Panel	36"w x 24"h	\$502	18^	\$738	19^
PB3636	ColorCork Tackable Panel	36"w x 36"h	\$620	25^	\$950	27^
PB3648	ColorCork Tackable Panel	36"w x 48"h	\$742	34*	\$1,048	36*
PB4836	ColorCork Tackable Panel	48"w x 36"h	\$742	34*	\$1,048	36*
PB4848	ColorCork Tackable Panel	48"w x 48"h	\$912	41*	\$1,236	44*
PB6036	ColorCork Tackable Panel	60"w x 36"h	\$1,036	45*	\$1,337	47*
PB6048	ColorCork Tackable Panel	60"w x 48"h	\$1,204	56*	\$1,593	60*
PB7236	ColorCork Tackable Panel	72"w x 36"h	\$1,057	57*	\$1,529	59*
PB7248	ColorCork Tackable Panel	72"w x 48"h	\$1,244	62*	\$1,686	65*
PB9648	ColorCork Tackable Panel	96"w x 48"h	\$1,563	80*	\$2,089	86*

^UPS Dimensional Weight Shipped by Truck\*  
 All board sizes are nominal. Contact factory for exact sizes/profile.

**Specifications & Ordering Information** (See page 115. For Accessories, see page 113.)



**TACTICS®**  
**Communication Boards**  
 ColorCork  
 Combination Writing Surface with Natural Cork, ColorCork or Fabric

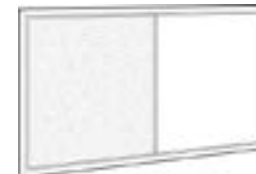
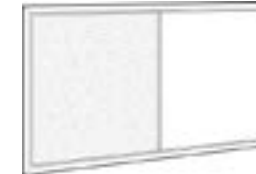

© 11/2024

© 11/2024





Model	Description	Size	Panel Width L/R	Profiles 5, 7		Profiles 8, 9	
				List	Est. Ship Weight	List	Est. Ship Weight
CT4836	Combo Board: Natural Cork (L)/ Writing Surface (R)	48"w x 36"h	24/24	\$927	34*	\$1,063	36*
CT7236	Combo Board: Natural Cork (L)/ Writing Surface (R)	72"w x 36"h	36/36	\$1,222	53*	\$1,405	55*
CT7248	Combo Board: Natural Cork (L)/ Writing Surface (R)	72"w x 48"h	36/36	\$1,513	68*	\$1,740	70*
CT9648	Combo Board: Natural Cork (L)/ Writing Surface (R)	96"w x 48"h	48/48	\$1,806	90*	\$2,073	94*
PT4836	Combo Board: ColorCork (L)/ Writing Surface (R)	48"w x 36"h	24/24	\$1,148	39*	\$1,647	40*
PT7236	Combo Board: ColorCork (L)/ Writing Surface (R)	72"w x 36"h	36/36	\$1,578	57*	\$1,919	60*
PT7248	Combo Board: ColorCork (L)/ Writing Surface (R)	72"w x 48"h	36/36	\$1,971	75*	\$2,398	77*
PT9648	Combo Board: ColorCork (L)/ Writing Surface (R)	96"w x 48"h	48/48	\$2,408	98*	\$2,883	107*
FT4836	Combo Board: Tackable Fabric Panel (L)/ Writing Surface (R)	48"w x 36"h	24/24	\$1,026	35*	\$1,177	37*
FT7236	Combo Board: Tackable Fabric Panel (L)/ Writing Surface (R)	72"w x 36"h	36/36	\$1,444	55*	\$1,666	57*
FT7248	Combo Board: Tackable Fabric Panel (L)/ Writing Surface (R)	72"w x 48"h	36/36	\$1,686	75*	\$1,943	77*
FT9648	Combo Board: Tackable Fabric Panel (L)/ Writing Surface (R)	96"w x 48"h	48/48	\$2,095	86*	\$2,408	90*

^UPS Dimensional Weight Shipped by Truck\*  
 All board sizes are nominal. Contact factory for exact sizes/profile.

**Specifications & Ordering Information** (See page 115. For Accessories, see page 113.)



**TACTICS®**  
**Communication Boards**  
 Wall Mounted  
 Specifications & Ordering Information

Profile Number	Name	Shape	Frame Finishes
5.	Slim Trim		Aluminum extrusion in Matte Aluminum, Black or Bright White.
7.	1/2 Round		Available in all Wood Finishes.
8.	Radius		Available in all Wood Finishes.
9.	Lineal		Available in all Wood Finishes.

See PPP Color Card or Web

**Frame Profiles**

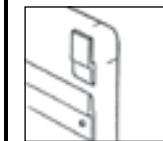
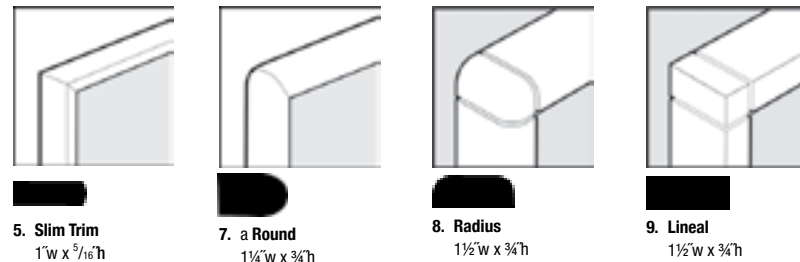

Wall Mount Cleat

All board sizes are nominal. Contact factory for exact sizes/profile.

**To Order Specify**

1. Quantity	<b>Frame Finishes</b>	<b>ColorCork</b>	<b>Fabric Selection - see page 115</b>
2. Model	<b>A</b> PPP Color	2186	Guilford of Maine
3. Profile Number	<b>CH</b> Cherry	2187	Sprite Style 2671
4. Frame Finish	<b>LC</b> Light Cherry	2209	Lido Style 2858
5. Fabric, ColorCork or COM	<b>HO</b> Honey		Crosstown Style 2526
6. <b>Accessories:</b> See pages 118 & 119	<b>MA</b> Natural Maple		COM: Customer's Own Material
	<b>MM</b> Mahogany		Page 121 for shipping information
	<b>LW</b> Light Walnut		
	<b>W</b> Walnut		

See PPP Color Card or Web

**TACTICS® Communication Boards**

- Available in 1 or 2 panel configurations with porcelain enamel dry erase Writing Surface, Fabric, COM, ColorCork or Natural Cork tackable panels.
- **Writing Surface:** White porcelain enamel writing surface consists of a specially formulated glass substance fused to 28 gauge steel. A porcelain enamel color cover-coat is applied to the ground-coat, then fused with a second firing operation to provide a glass hard, smooth surface that is non-porous, non-absorbent and acid resistant.
- The TACTICS® writing surface can be used for projection presentations and will accept magnetic accessories.
- Pen Rail (12" aluminum, magnetic attachment), 4 markers and eraser included with each board.
- **Natural Cork Tackboard:** Natural cork laminated to a 1/8" thick fiberboard.
- **ColorCork:** Washable, tackable surface which reseals itself after pins are removed. Ideal for clean room environments. For ColorCork specifications, see page 115.
- **Wall mounting cleat/bracket & hardware included.**
- **Custom Sizes:** Custom sizes, other configurations and silk-screening available. Please submit your requirements.
- **Shipping:** All units are fully assembled and cartoned. For Accessories, see page 113.



**TACTICS PLUS®**  
 Advanced Training System  
 Accessories

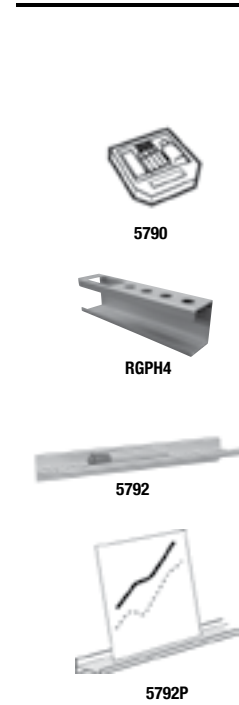

Model	Description	Size	List	Est. Ship Weight
5790	12 Dry Erase Markers, Eraser, Board Cleaner		\$142	2
RGP2	Marker and eraser holder. Holds 2 markers and 1 eraser. Accessories not included. Double sided tape included.	7" w x 2 3/4" h x 2" d	\$39	
RGP4	Marker and eraser holder. Holds 4 markers and 1 eraser. Accessories not included. Double sided tape included.	10" w x 2 3/4" h x 2" d	\$55	
5789	Pen Rail: Natural Anodized Aluminum w/ polished edges. Includes 4 Dry Erase Markers and Eraser. Magnetic Attachment.	12" w x 2 1/4" d	\$90	2
5791	Pen Rail Only: Natural Anodized Aluminum w/ polished edges. Magnetic Attachment.	12" w x 2 1/4" d	\$46	2
5792	Pen Rail Only: Natural Anodized Aluminum w/ polished edges. Custom Length, up to 96". Price per foot. Screw attachment to any Track Level 2 Panel only.	??" w x 2 1/4" d	\$46	2
5792P	Presentation Rail Only: Custom Length, up to 96". Natural Anodized Aluminum with polished edges. Screw attachment to any Track Level 2 Panel only.	??" w x 2 1/4" d	\$46	2

^UPS Dimensional Weight

**To Order Specify**

1. Quantity
2. Model



© 11/2024

© 11/2024



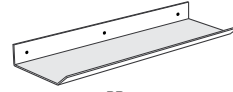

PR



PR  
Cross-section

Presentation & Display Rails			List	Est. Ship Weight
Model	Description	Size		
PR12	Presentation Rail	12"w x 2"h x 5 ½"d	\$80	3
PR24	Presentation Rail	24"w x 2"h x 5 ½"d	\$162	5
PR36	Presentation Rail	36"w x 2"h x 5 ½"d	\$243	8
PR48	Presentation Rail	48"w x 2"h x 5 ½"d	\$324	11^
PR60	Presentation Rail	60"w x 2"h x 5 ½"d	\$405	13^
PR72	Presentation Rail	72"w x 2"h x 5 ½"d	\$485	15^
PR84	Presentation Rail	84"w x 2"h x 5 ½"d	\$568	18^
PR96	Presentation Rail	96"w x 2"h x 5 ½"d	\$648	21^

^UPS Dimensional Weight

**To Order Specify**

1. Quantity
2. Model

**Specifications**

- Finish: Natural Anodized Aluminum.
- Extruded aluminum, 1/8" thick. Screw mount to wall. Load capacity: 15 lbs. per 48" shelf, uniformly distributed static load.

© 11/2024

© 11/2024



**1. Guilford of Maine**

**Sprite Style 2671**

- |             |             |
|-------------|-------------|
| 010 Linen   | 030 Khaki   |
| 020 Butter  | 032 Harvest |
| 031 Kiwi    | 040 Snow    |
| 012 Sherbet |             |

**Lido Style 2858**

- |                  |                 |
|------------------|-----------------|
| 024 Oak Bluffs   | 023 Cape May    |
| 010 Hermosa      | 030 Newport     |
| 065 Bryce Canyon | 031 Smith Point |
| 019 Balboa       |                 |

**Crosstown Style 2526**

- |              |                |
|--------------|----------------|
| 010 Cement   | 040 Waterfront |
| 030 Ray      | 060 Fieldstone |
| 070 Stucco   | 080 Buff       |
| 021 Graphite |                |

To order samples, visit online sample service: <http://www.guilfordofmaine.com>

**2. ColorCork**

- 2186
- 2187
- 2209

**ColorCork Specifications**

- ColorCork is made from pure, granulated cork and natural ingredients that are combined under heat and pressure to create a smooth, suede-like surface of exceptional durability.
- ColorCork is washable, tackable and reseals itself after push-pins are removed. The cork naturally inhibits bacterial growth and is environmentally friendly with no toxins or harmful by-products or emissions.
- The ColorCork surface does not crack, peel or crumble and has low light reflectance.
- Meets ASTM E-84, class B and NFPA 253, Class II.

Samples available on request via Forbo Linoform, Inc., 800-842-7839 x 712.

**3. COM - Customer's Own Material**

Optional COM - Customer's Own Materials are available on most tackable panels.

**Shipping Instructions for COM**

When ordering material, customer must have supplier of material mark the following information on the outside of the package.

1. Buyer's name.
2. Purchase Order Number to PPP.
3. Purchase Order date.
4. Work Order Number material is to cover.
5. Quantity and model number(s) material is to cover.
6. Specify fabric direction: conventional or railroad.

**All materials to be shipped FREIGHT PREPAID to:**

Peter Pepper Products, Inc., 6525 Flotilla Street, Commerce, CA 90040.

**Responsibility for COM shipments:**

- We cannot be held responsible for performance of COM covering materials, nor shall we be held responsible for yields or variations in tone or weaving.
- All responsibility for COM shipments is between the buyer and the source.



## Section 11

### WHEELIES® MOBILE AV MEDIA SUPPORT PRODUCTS

Lecterns  
Work Stations  
Hospitality & File Storage Carts  
Media Carts & Equipment Stands

#### PRICE LIST & SPECIFICATIONS

Effective January 1, 2026

All Prices are Suggested List Price

Updated 11.03.25



### WHEELIES® Mobile AV Media Support Products



7900-42



7902-42



7905-42



7907-42



7925



Aluminum Circular Frame

©11/2024

©11/2024





Model	Description	Overall Size	Top Size	Standard Finishes	Est. Ship Weight
7900-42	AV/Media Cart: open front, 2 adjustable shelves	20"w x 42"h x 16"d	23 ¾"w x 18 ¼"d	\$1,349	81*
7902-42	AV/Media Cart: w/ 1 hinged, locking door, 2 adjustable shelves	20"w x 42"h x 16"d	23 ¾"w x 18 ¼"d	\$1,842	80*
7905-42	AV/Storage Cart: open front, 2 adjustable shelves	30"w x 42"h x 20"d	33 ¾"w x 23 3/8"d	\$1,571	102*
7907-42	AV/Storage Cart: w/ 2 hinged, locking doors, 2 adjustable shelves	30"w x 42"h x 20"d	33 ¾"w x 23 3/8"d	\$2,380	127*
7925	Equipment Cart: w/ 1 hinged, locking door, 1 adjustable shelf	20"w x 30"h x 16"h	23 ¾"w x 18 3/8"d	\$1,429	69*
<b>Options</b>					
7839	Surge Protector Power Strip with multiple receptacles			\$90	3

Shipped by Truck\*

Specifications & Ordering Information (See page 118.)



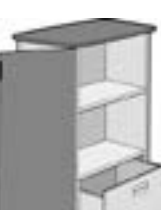
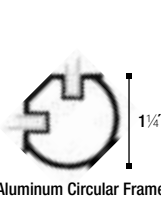

Model	Description	Overall Size	Top Size	Standard Finishes	Est. Ship Weight
 7935	Lectern: open front, 2 adjustable shelves. Natural Anodized Aluminum Pen/Paper Stop	20"w x 44"h x 16"d	23 3/4"w x 20 1/2"d	\$1,337	73*
7937	Lectern: (1) 6"h open shelf, (1) 28"h hinged locking door, 1 adjustable shelf. Natural Anodized Aluminum Pen/Paper Stop	20"w x 44"h x 16"d	23 3/4"w x 20 1/2"d	\$1,743	91*
 7942-30	Mobile Work Station: w/ (2) 18"h hinged, locking doors, 1 adjustable shelf, grey keyboard tray 20"w x 8 1/2"d, on adjustable ball bearing slides, 15" length	30"w x 30"h x 20"d	33 3/4"w x 23 3/8"d	\$2,297	101*
 7942-42	Mobile Work Station: w/ (2) 30"h hinged, locking doors, 2 adjustable shelves, grey keyboard tray 20"w x 8 1/2"d, on adjustable ball bearing slides, 15" length	30"w x 42"h x 20"d	33 3/4"w x 23 3/8"d	\$2,675	125*
 7860	Keyboard Tray: fully articulating with left or right hand mouse pad. 6" Height Adjustment. 360° Arm Rotation. Meets BIFMA standards.	20"w x 8 1/2"d	9"w x 8 1/2"d	\$681	18
 7990	Mobile File and Storage: 1 hinged locking door, 1 adjustable shelf, letter/legal file drawer	26"w x 42"h x 21"d	29"w x 23 1/2"d	\$2,840	140*
<b>Options</b>					
7839	Surge Protector Power Strip with multiple receptacles			\$90	3
Shipped by Truck*					



Aluminum Circular Frame

**To Order Specify**

<ol style="list-style-type: none"> <li>1. Quantity</li> <li>2. Model</li> <li>3. Top &amp; Door(s): Textured PPP Color</li> <li>4. Side &amp; Back Panel Finish</li> <li>5. Option</li> </ol>	<p><b>Side &amp; Back Panel</b></p> <p>Cool Grey Black Cherry Natural Maple</p> <p><i>See PPP Color Card or Web</i></p>
---	---

**Specifications**

- Top & Door(s): Medium density fiberboard in any Textured PPP Color.
- Hinged doors open 270°.
- Side and back panel: Melamine.
- Interior Finish: Cool Grey Melamine.
- Frames: Natural Anodized Aluminum.
- 3" Locking casters.
- Wire Grommets: Oval grommet, 6"w x 2 1/2"h, located at top & bottom of back panel, except model 7990.
- 2" grommets through shelves. Except Models 7935-7937, & 7990.
- Custom sizes available. Please submit your requirements.

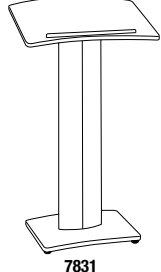
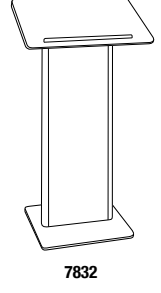

Model	Description	Overall Size	Top Size	Wood Lam Finish	Standard Finishes	Est. Ship Weight
 7831	Stand-up Lectern: 9" column, 20"w x 16"d pedestal base. Natural Anodized Aluminum Pen/Paper Stop.	27"w x 47"h x 18"d	27"w x 18"d	N/A	\$1,798	48*
 7832	Stand-up Lectern: 15 1/2" column, 20"w x 16"d pedestal base. Natural Anodized Aluminum Pen/Paper Stop.	27"w x 47"h x 18"d	27"w x 18"d	\$2,003	\$1,693	64*
Shipped by Truck*						

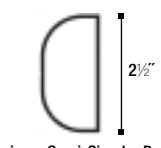

Aluminum Semi-Circular Profile

**To Order Specify**

<ol style="list-style-type: none"> <li>1. Quantity</li> <li>2. Model</li> <li>3. Frame Finish Code: PPP Color Upcharge: 15%</li> <li>4. Panel Color: Cool Grey or Black. PPP Color Upcharge: 15%</li> <li>5. Add NET Crating Charge</li> </ol>	<p><b>Frame Finishes</b></p> <p><b>RA</b> Natural Anodized Aluminum <b>RC</b> PPP Color - Upcharge</p>	<p><b>Wood Laminate Finishes - Models 7832</b></p> <p><b>CH</b> Cherry WA 7924-07 <b>LC</b> Light Cherry WA 7919-38 <b>HO</b> Honey Pionite WM951-S <b>MA</b> Natural Maple WA 7909-60 <b>MM</b> Mahogany WA 7922-07 <b>W</b> Walnut Lamin-Art 2608-T</p>
--	--	---

*See PPP Color Card or Web*

**Specifications**

- All models are fully assembled, crated and palletized.
- Custom sizes available. Please submit your requirements.





PETER PEPPER PRODUCTS  
EXPRESSIVE ESSENTIALS®

**2025 PRICE  
LIST**

**PETER PEPPER PRODUCTS, INC.**  
**6525 Flotilla St**  
**Commerce CA 90040**

**T: 800 496 0204**

**W: [www.peterpepper.com](http://www.peterpepper.com)**

**E: [customerservice@peterpepper.com](mailto:customerservice@peterpepper.com)**